

Direct Sampling SDR transceiver

SunSDR2 PRO

HF/50 MHz/VHF TRANSCEIVER

USER MANUAL

1. READ IT FIRST	6
1.1 Congratulations	6
1.2 Features	6
1.3 Supplied accessories	7
1.4 Precautions	8
1.5 ExpertSDR2 Software License Agreement	9
1.6 Copyrights	10
1.7 Contacts	10
2. FRONT PANEL DESCRIPTION	11
3. REAR PANEL DESCRIPTION	12
3.1 Antenna	13
3.2 Grounding	14
3.3 Accessories	14
3.4 External Linear Amplifier	15
3.5 External Control devices	16
3.6 Reference input	17
3.7 Transverter connection	17
3.8 DAC OUT low power output	17
3.9 ADC IN and RX OUT	18
4. CONNECTORS PIN-OUT	19
4.1 MIC1	19
4.2 MIC2	19
4.3 EXT CTRL	20
5. ExpertSDR2 SOFTWARE DESCRIPTION	22
5.1 Global controls panel	22
5.2 Software transceiver settings	26
5.2.1 Transceiver control panel	26
5.2.2 Frequency and S-meter indicators	40
5.2.3 DSP control panel	42
5.2.4 Panorama description	44
5.2.4.1 Spectrum Scope	45
5.2.4.1.1 Spectrum Scope scaling	45
5.2.4.2 Waterfall	46
5.2.5 Status bar	46
5.3 Options	48
5.3.1 Device menu	48
5.3.1.1 Mic	49
5.3.1.2 VAC	50
5.3.1.3 VOX	51

5.3.1.4	DSP	51
5.3.1.5	TX	54
5.3.1.6	CW	56
5.3.1.7	Ext Ctrl	57
5.3.1.8	Expert	58
5.3.2	Sound card menu	61
5.3.2.1	Sound card	61
5.3.2.2	Line output	62
5.3.3	Display menu	63
5.3.3.1	Main window	63
5.3.3.2	Spectrum	64
5.3.3.3	Waterfall	67
5.3.3.4	Grid	68
5.3.3.5	Filter	68
5.3.3.6	Background	69
5.3.3.7	Indicators	70
5.3.4	CAT menu	71
5.3.4.1	ECATv1	71
5.3.4.2	OmniRig	73
5.3.5	Panel menu	74
5.3.6	Features menu	79
5.3.7	ExpertSync menu	80
5.3.8	CW Skimmer menu	80
5.3.9	Shortcuts menu	82
5.3.10	IQ Recorder menu	83
5.3.11	TCI menu	83
5.3.12	Spot settings menu	84

6. TECHNICAL CHARACTERISTICS 85

6.1	Receiver	85
6.2	Transmitter	86
6.3	Other	87

7. TRANSCEIVER OPERATIONS 88

7.1	Local operation	88
7.2	Remote operation	88
7.3	Frequency Tuning	88
7.4	Antenna switch	89
7.5	Voice Recorder Operation	90
7.6	Transverter mode operation	91
7.7	Split operation	91
7.7.1	SPLIT + Sub RX Operation	92
7.8	RIT/XIT	92
7.8.1	RIT	92
7.8.2	XIT	93
7.9	Digital modes operation	94

8. RESET SETTINGS AND FIRMWARE	95
9. REGULATORY REQUIREMENTS	97

1 READ IT FIRST

1.1 Congratulations

On behalf of the whole Expert Electronics company, we'd like to thank you for purchasing one of the best modern SDR transceivers!

The SunSDR2 PRO transceiver is the best size/capability SDR transceiver which is perfect for contests and DXpeditions!

1.2 Features

The SunSDR2 PRO transceiver was designed for advanced operation on HF and VHF bands, even the most demanding operator will be surprised by its capabilities. Modern hardware along with the ExpertSDR2 software makes this high-performance SDR transceiver the perfect base station and at the same time perfectly suitable for field operations.

Main features and capabilities of the transceiver

- Independent RX path based on **DDC** (Direct Down-Conversion) architecture
- Independent TX path based on **DUC** (Direct Up-Conversion) architecture
- **ExpertRemote system** provides full remote control of the transceiver
- An opportunity to use the transceiver in the **SO2V** mode
- Full or half-**duplex** mode*
- 2 software receivers (each up to 312 kHz) + SubRX for each of them (**4 slices total**) + independent wideband **Bandscope up to 80 MHz**
- Antenna switch with 2 HF antenna connectors and separate VHF antenna connector
- Supports use of VHF **transverters**
- An opportunity to use the transceiver as a signal generator via **DAC OUT** connector
- Built-in power-meter and SWR-meter for HF bands
- **ExtCTRL** connector to control external devices with 8 powerful keys with open collector
- **Ethernet LAN** interface provides fast and reliable connection to PC
- **ALC** connector for external power amplifiers**
- **TCI interface** for seamless connection with third-party software like **SDC** (with its own Skimmer), **LogHX**, **SWISSLOG** and **RUMlog**, more are coming
- **Professional TX processing module** provides the most advanced tuning capability for voice operation
- Small delay in CW mode (about 10 ms)

Full-duplex mode is supported by the transceiver's hardware but is not implemented in the firmware and software yet. This mode will be implemented in future versions of ExpertSDR2 software.

** ALC functionality is supported by the transceiver's hardware but is not implemented in the ExpertSDR2 software. It will be supported in the ExpertSDR2 1.3 software release.

PC requirements

- CPU Intel Core i3 1.6 GHz and higher
- 8GB RAM
- Video card, minimum resolution 1024x600, 128 MB, OpenGL 1.5 support and higher
- Local network connector 100 Mbps or 1 Gbps
- The ExpertSDR2 works with Windows 7-10, OS Linux Ubuntu x64 and macOS 10.12 and newer

Block Diagram

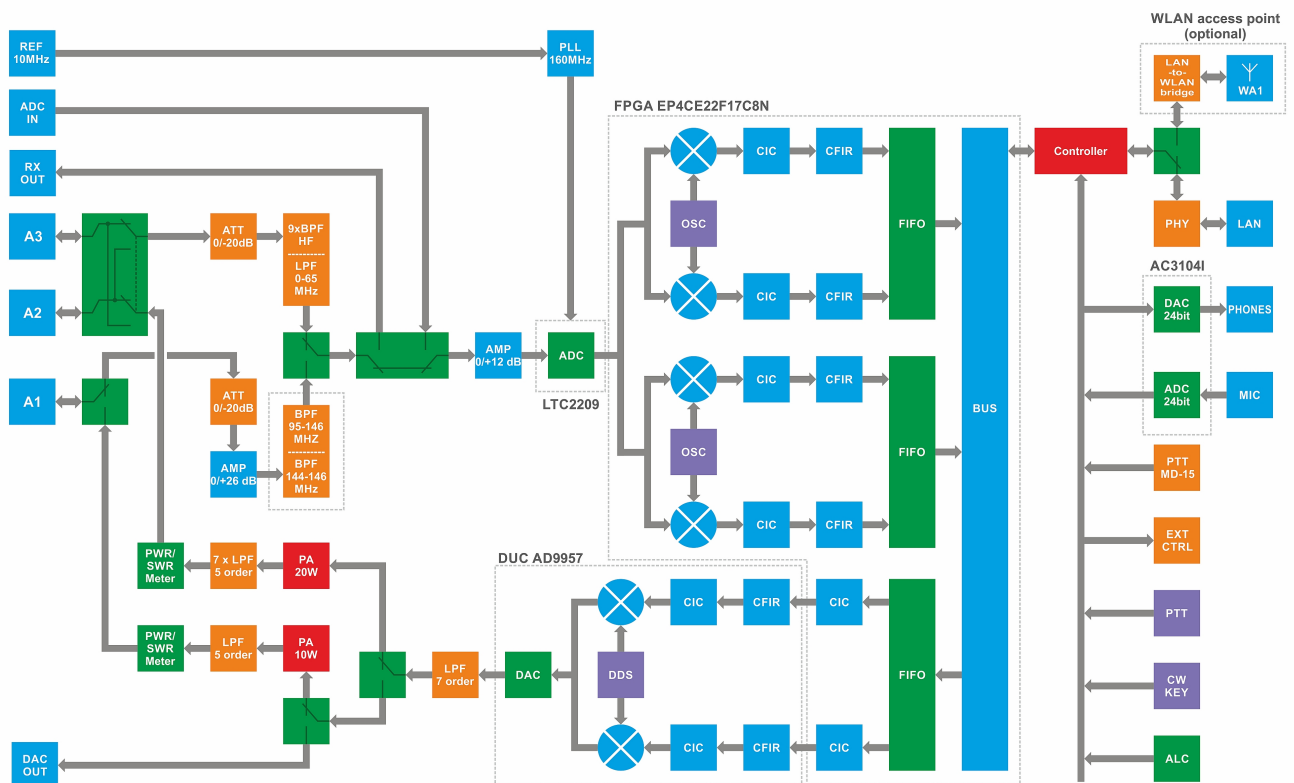

1.3 Supplied accessories

- SunSDR2 PRO transceiver
- LAN-cable for connection to a local network (1.8m)

- Power cable for connection to a power supply (2m)
- Audio-adapters JACK 6.3mm to JACK 3.5mm (2 pcs.)
- RF Cable Mini UHF – HF (PL259) 1Ft (0.3m 1 pc.)

Additional equipment:

Additionally you can purchase the following devices:

- [E-Coder Plus](#), [E-Coder panel](#) or [E-Coder mini kit](#) for convenient remote operation
- [PTT footswitch](#)

1.4 Precautions

To prevent any damage to the transceiver, please read these operating rules carefully before attempting to operate on the air.

- Carefully read this manual first, otherwise connecting and operating the SunSDR2 PRO could lead to fatal errors
- Visually inspect the SunSDR2 PRO transceiver for the absence of mechanic damages before connecting it to PC
- Before connecting the SunSDR2 PRO to the AC power line, ensure it is grounded. Never use the SunSDR2 PRO transceiver without grounding
- It is forbidden to connect the SunSDR2 PRO to PC with the voltage presence on it or in the switched condition
- It is forbidden to use the power supply with the voltage higher than +16 V. **Remember! The transceiver's power is the voltage direct current!**
- Connecting the Transceiver to a PC should be done in accordance with the connection diagram, given in the Manual
- If the SunSDR2 PRO was stored in abnormal climatic conditions, it is recommended to keep it in normal operating temperatures for at least 2 hours before switching on
- It is forbidden to use and store the Transceiver in the dusted rooms and expose it to direct sunlight for a long time
- Before connecting the external devices to connector EXT CTRL read the Manual, learn tables and diagrams of connecting the external devices
- **DO NOT** connect a VGA monitor to EXT CTRL port, you will damage the transceiver!
- **Remember!** The transistor switches have limitations of supply voltage and current, going through them. **DO NOT allow polarity reversal!**
- **DO NOT** use the SunSDR2 PRO in temperatures lower than 0°C (32°F) and higher than +75°C (167°F)

- **DO NOT** emit HF/VHF signal with power more than 1W in the same room or near the Transceiver
- **DO NOT transmit without a load** (dummy load/matched antenna) - it will lead to overheating of the engaged components and may result in their failure. The same applies to an unmatched load
- Avoid the exposure of the atmospheric downfalls on the SunSDR2 PRO and never spill any liquids (especially aggressive) on it
- **It is forbidden to use the Transceiver during storms!**
- **Always disconnect the antenna** from the Transceiver when not in use, or if there is a danger of atmospheric electricity
- **Don't open the Transceiver**, it has radio elements, which have high-sensitivity to the static electricity. This document contains all necessary information about the internal design to satisfy the Users' curiosity. To repair the Transceiver, ask the manufacturer
- Ensure the Transceiver and any connecting cables are free from the effects of electromagnetic interference and uncontrolled currents and voltages
- To avoid damage to the Transceiver or causing harmful interference on air, it should only be operated by licensed HAMs
- Keep the Transceiver out of the reach of children
- If the transceiver emits an abnormal odor, or smoke, **immediately** turn it OFF and remove the power cable. Contact your closest Expert Electronics dealer for advice
- **Always** take great care when moving or transporting the transceiver
- Ground the antenna-mast and antenna-feeders to avoid accumulation of atmospheric static electricity on them
- **Always** use ferrite beads on antenna and other cables, connected to the transceiver

1.5 ExpertSDR2 Software License Agreement

The ExpertSDR2 software is the proprietary product and intellectual property of Expert Electronics. It is forbidden to modify, copy or disclose to third parties ExpertSDR2 software distribution.

Official versions of the software are published on the manufacturer's website in the section "SunSDR2 PRO Transceiver/Downloads".

New versions of the SunSDR2 PRO transceiver software may have different titles from time to time. This license agreement applies to all new versions of the software and may be supplemented and/or amended unilaterally by Expert Electronics.

The manufacturer reserves the right to alter and/or improve the SunSDR2 PRO transceiver software, adding new features and bug fixes. In this regard, the software may be different from the description herein. Ask your closest dealer on the availability of new, more complete version

of the User Manual, or look for them on the official website of the manufacturer in the section "SunSDR2 PRO Transceiver / Documentation".

Users of the SunSDR2 PRO transceiver can update the software by themselves, by downloading from the official website of the Expert Electronics company.

The manufacturer is not responsible for the consequences of the user utilizing an unofficial or modified version of the ExpertSDR2 software and/or changes the settings or other files which are related to the ExpertSDR2 functionality.

The manufacturer assumes no responsibility for the material, moral or any other kind of damage, whether expressed or implied, caused by using of a third-party software.

The manufacturer assumes no responsibility for the material, moral or any other kind of damage, whether expressed or implied, caused by using of external devices along with the SunSDR2 PRO transceiver.

1.6 Copyrights

Expert Electronics company holds copyrights for the SunSDR2 PRO transceiver, intellectual property: ExpertSDR2 software and all User Manuals and Instructions for the device and software.

It is forbidden to present this document as your own, sell it or use it in any other commercial activity.

Expert Electronics company does not guarantee, that the functions and their qualities described in this manual, and also combinations which were not described in the manual, comply with the User purposes, if it is not mentioned in the Manual. Expert Electronics company does bear any responsibility for the material, moral or other kinds of damage expressed or implied by such actions.

1.7 Contacts

MANUFACTURER

Expert Electronics

Web-site: www.eesdr.com

E-mail: info@sunsdr.com

You can contact us via mentioned above mail address about: your orders, inquiries, technical support, software support.

2 FRONT PANEL DESCRIPTION

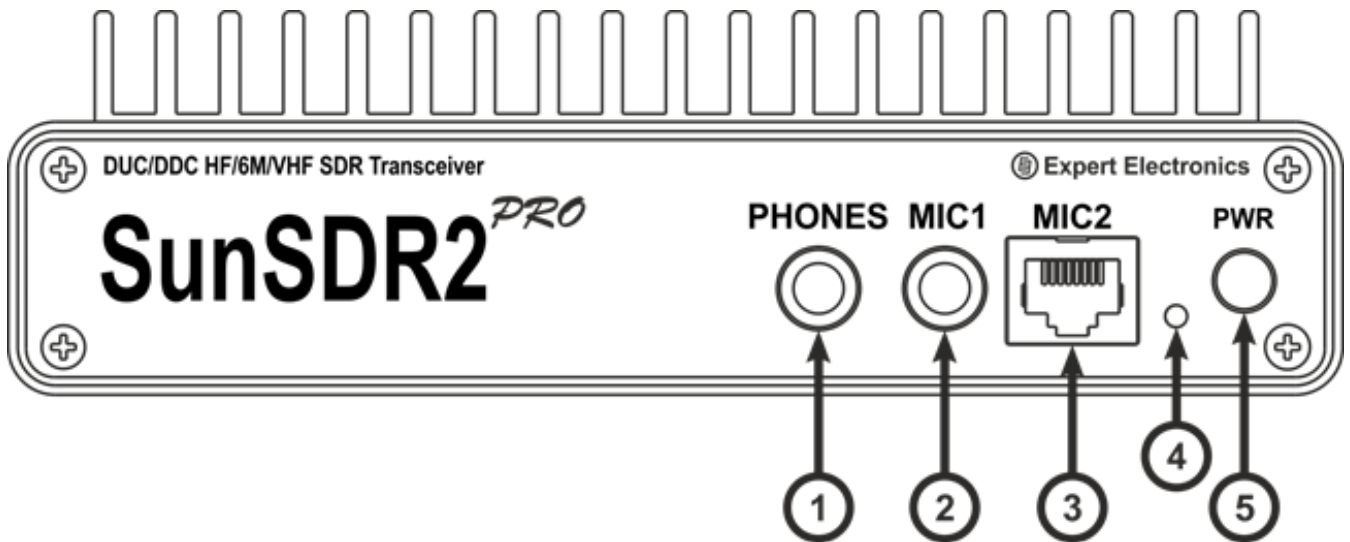

#	Name	Description
1	Headphones jack jack 6.3	Here you may connect headphones with 16-30 Ohm impedance or speakers. Warning! Never use headphones with a mono connector! If you have a monophonic headphones, use the stereo 6.3 mm Jack and connect them to one of the channels. Warning! Never connect two stereo channels with each other! <i>ote: Headphones with high impedance may sound quieter.</i>
2	Electret microphone jack 6.3	Here you may connect an electret microphone from a PC's headset.
3	Dynamic microphone	Here you may connect a dynamic microphone MH-31 or any other dynamic microphone with the RJ-45 connector and similar pinout. Allowed output impedance is 500-600 Ohm.
4	Power and connection LED indicator	This indicator displays operation modes of the transceiver: - green color: LAN is active/connected; - orange color: WiFi is active/connected (when the transceiver has a WiFi option); - red color: transmit mode is "ON"; - blinking green or orange color: network setup state, wait until blinking stops.
5	Power on/off button	Press the button to power on/off the transceiver.

3 REAR PANEL DESCRIPTION

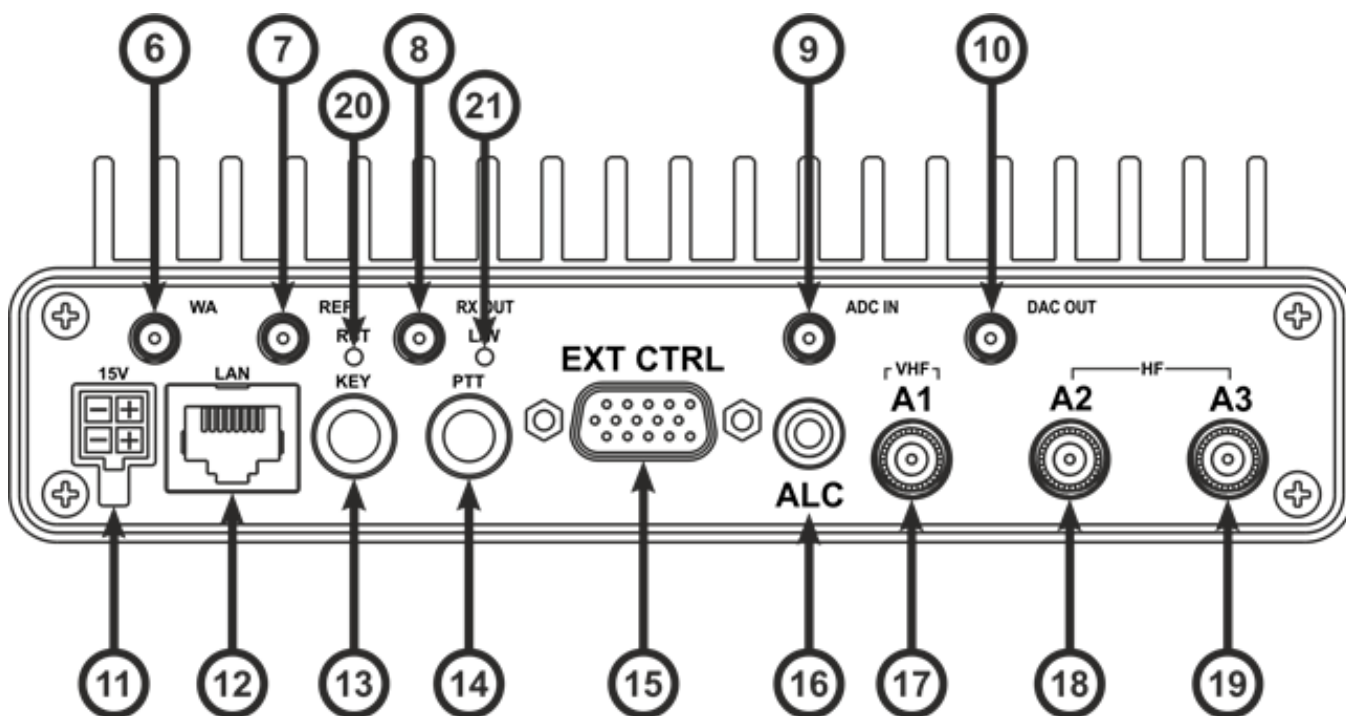

#	Name	Description
6	WLAN antenna connector	This connector is installed when the transceiver has a WiFi (WLAN) option.
7	External reference oscillator Input 10 MHz 10 MHz CMOS level input	Appropriate Voltage amplitude for this input: 1...3 V Pk-to-Pk and 10 MHz frequency. Input impedance 2 kOhm. Warning! Improper use or higher voltage may damage the transceiver!
8	RX OUT	Internal receiver's front-end output. Warning! Improper use or higher voltage may damage the transceiver!
9	ADC IN	Direct input, bypassing Band Pass Filters (BPFs). ADC IN connector may be used for connection of the receiving antennas, transverters, additional BPFs, preamplifiers, attenuators etc. Warning! Improper use or higher voltage may damage the transceiver!
10	DAC OUT	Direct output, bypassing Band Pass Filters (BPFs). The output can be used for connection of the external power amplifiers,

		transverters and as a generator of the measuring signal. Transmission is possible only on the amateur bands. Warning! Improper use or higher voltage may damage the transceiver!
11	Power connector	Connector is intended for connection of DC power source with voltage of up to +15V and maximum load current 5A. Transceiver has a shutdown circuit, protecting device from the power polarity reversal.
12	LAN connector	LAN connector for connection of the transceiver to the local network via the LAN cable.
13	KEY connector, jack 6.3	CW key connector.
14	PTT footswitch connector, jack 6.3	PTT footswitch connector
15	EXT CTRL connector	Use this connector to control external devices. Warning! Improper use of this connector may damage keys!
16	ALC input	ALC input for external power amplifier
17	A1 connector for VHF antenna	VHF antenna connector. Use it when you want to operate on 2m band.
18, 19	A2 and A3 connectors for HF antennas	Use these connectors when you want operate on HF or 6m band.
20	RST (reset) button	Press this button to reset IP-address and UDP-ports of the transceiver to the default IP values: 192.168.16.200, ports: 50001, 50002.
21	LAN / WLAN (Wi-Fi) switch button	Press this button to switch the transceiver from LAN to WLAN. If WLAN option is not installed, transceiver will not operate when the WLAN mode is selected. Single pressing of the button changes operation mode.

3.1 Antenna

Before connecting the antenna, check the integrity of the antenna-feeder path.

For best results, the antenna should have an impedance of 50 Ohm to match the 50 Ohm impedance of the HF nodes of the transceiver.

The antenna should have SWR level not worse than 1.5:1. If the SWR is worse than 1.5:1, match the cable and the antenna to the desired level and/or use an ATU.

Note:

•Using a mismatched antenna-feeder path might cause non-linear distortion of the transmitted signal, HF interference on the transceiver's cables and/or interference of TV's or other devices.

•Transmitting with a receiving antenna may damage it.

Warning!

① Always use E-type ferrite beads on antenna and other cables, connected to the transceiver!

3.2 Grounding

To eliminate the risk of electric shock it is essential to use a reliable grounding connection for the transceiver, the best grounding point is the antenna connector.

Warning!

① Never use water or gas pipes for grounding!

① Never use the SunSDR2 PRO transceiver without a reliable grounding!

3.3 Accessories

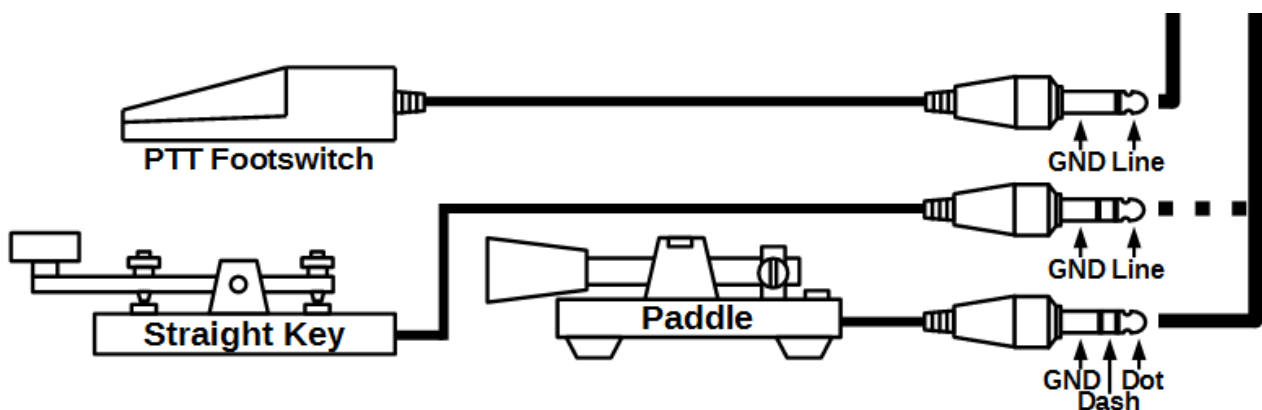

You can connect several accessories to the transceiver's rear panel, as shown on the picture above.

PTT Footswitch should be connected to the **PTT** socket, it controls the transceiver's TX mode. Connector type - 6.3 mm Jack.

When you press the footswitch, **PTT** Line connects to the Ground (Case), it turns the transceiver to TX. A **red** LED TX indicator on the front panel and in the software window, indicates that the TX mode is on.

Releasing the footswitch returns the transceiver to the RX mode.

Straight Key should be connected to the **KEY** socket using the mono 6.3 mm Jack. Pressing the key turns the transceiver to the TX mode and it generates a continuous CW signal (manual mode).

Releasing the straight key returns the transceiver to the RX mode.

Twin-paddle key (single-paddle) should be connected to the **KEY** socket using the mono 6.3 mm Jack. Pressing one of the key's paddles (or one side - for single-paddle) will turn the transceiver to the TX mode and begin automatic generation of dots and dashes.

Releasing the paddle returns the transceiver to the RX mode.

CW key connection via COM-port.

CW paddle can also be connected to the **COM**-port of your PC, according to the picture below.

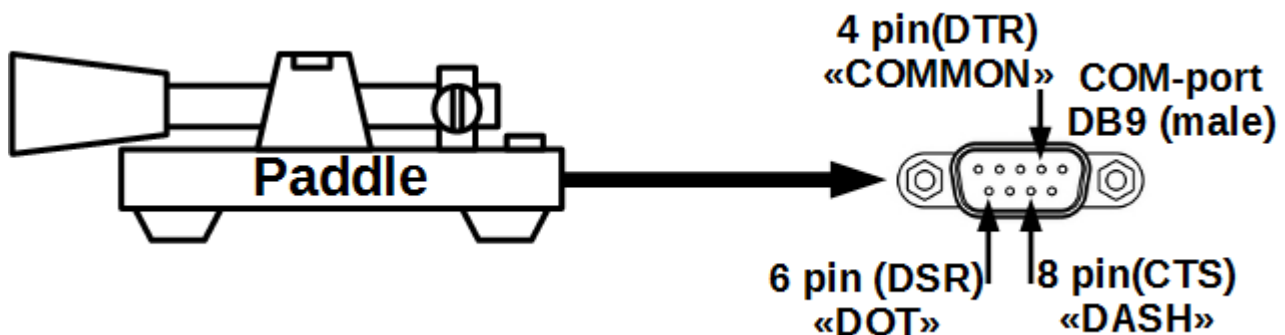

In the ExpertSDR2 DOT/RTS = DOT/CTS and DASH/DTR = DASH/DSR.

In the ExpertSDR2 you set COM-port pins of your PC, which uses DTR and RTS for keying. DTR and RTS from PC should be connected to local DSR and CTS pins, which are showed on the picture with the paddle. DSR and CTS are RX lines (inputs) that is why they used like this.

3.4 External Linear Amplifier

You can connect external Power Amplifiers (PAs) to the transceiver.

It may be required to make several connections depending on the required external PA type.

Connect a 50 Ohm HF cable to the transceiver's antenna connectors A2, A3 or A1 if it's a VHF PA, connect the other end of the cable to the input of the PA.

To control the TX mode of the external PA you can use the X8 pin terminal of the **EXT CTRL** connector (more details in [EXT CTRL devices](#)¹⁶).

If an external PA supports operation with the transceiver's **ALC** system, you can connect it via cable with RCA-type phono plugs. The ALC voltage range -3...0 V (see the **warning** below).

Note:

•While connecting the cables, transceiver and PA should be switched off.

Warning!

- ① **There is a small delay in the ALC-system functionality, which may lead to a short-term overload of the external PA. This phenomenon could cause off-frequency emissions or failure of your PA! The User of the transceiver should understand and accept the above, taking responsibility for the potential consequences of using the ALC-system. The manufacturer is not responsible for direct or indirect damages of any kind from using the ALC-system.**
-

3.5 External Control devices

The SunSDR2 PRO transceiver allows you to control external devices via seven electronic keys in the **EXT CTRL** connector.

With the keys you can have direct control of antennas, external band pass filters, external PA's bands, HF preamplifiers, external transverter PTT etc. Commutation depends on the band and RX/TX mode.

You can adjust Ext CTRL operation in the software Settings (more details in [EXT CTRL](#)^{D57}).

The **X7** key can be configured as thermostat for enabling of the external fan. The transceiver measures the internal temperature and enables or disables external fan, depending on the settings (adjusted by the User). An external fan can be used for additional ventilation of the transceiver. You could also connect a relay to this key to control the room cooling system or other systems, dependent on the transceiver's temperature.

Note:

- *The Electronic keys have a built-in protection diodes for inductive loads (relays, fans, solenoids, etc.) with a maximum reverse voltage of 75 V and current up to 200 mA (1N4148 diodes). If your inductive load gives a higher reverse current, it is necessary to use an external diode in parallel to the connected load.*
 - *The **X8** key is designed for control of the external PA.*
-

Warning!

- ① **Never use a VGA cable from your monitor, to connect external devices**
- ① **Never connect monitors with the VGA interface to the ExtCTRL connector**
- ① **Incorrect connection of external devices and / or uncontrolled galvanic connections could lead to the malfunctions of the transceiver or its failure!**
-

3.6 Reference input

A 10 MHz external reference oscillator can be connected to the **REF IN** connector with a coaxial cable.

Set the **Use external reference** checkbox in the ExpertSDR2 menu to use an external reference oscillator (more details in [Device](#)^{□48} menu).

Signal parameters of the Reference Frequency:

- Reference signal frequency of 10 MHz
 - Reference signal voltage: min. 2.5 V; max. 3.3 V
 - Input impedance of 500 Ohm
 - SMA type connector (female)
-

Note:

•Use an external reference oscillator via **REF IN** connector to increase the stability of the transceiver's tuning frequency, if +/- 0.5 ppm stability is not enough. Also transceiver's frequency synchronization with an external reference oscillator is used when you want to sync several devices with each other, from one reference oscillator.

•The Phase frequency of the transmitted and received signals depends on the phase frequency of the external reference oscillator.

3.7 Transverter connection

Connect VHF, SHF transverters to the **A1** connector of the transceiver.

VHF, SHF transverter may also be connected to the transceiver via the **ADC IN** and **DAC OUT** connectors.

ADC IN used as the input in the RX mode. **DAC OUT** used as the output in the TX mode.

The **DAC OUT** does not have a constant voltage to control the TX mode, so it is necessary to use an additional control line while you use the **DAC OUT** in the TX mode. For this you may use any **EXT CTRL** key (more details in [EXT CTRL devices](#)^{□16}).

3.8 DAC OUT low power output

The **DAC OUT** is the transceiver's low-power output, which functions in the wide frequency band. It could be used for connection of external power amplifiers, transverters and as a source of measuring signal.

To use the **DAC OUT** enable it in the [antenna switch](#)^{□89}.

DAC OUT output parameters:

Max output power: 10 mW

Frequency band: 0.1...150 MHz

Transmitted signal band: 20 kHz

Impedance: 50 Ohm

Signal level: +10 dBm (max)

3.9 ADC IN and RX OUT

The **ADC IN** connector is the direct receiver input, bypassing Band Pass Filters (BPFs). Use the **ADC IN** for connection of RX antennas, transverters, additional BPFs, preamplifiers, attenuators etc.

Note:

•The signal from **ADC IN** connector goes directly to the ADC input and may be amplified by the +10dB preamplifier, if you set it in the software.

Warning!

① **Maximum allowed signal level on the RX IN connector is 0.3V of the active voltage (RMS). Do not exceed this level, it may result in the transceivers overload and ADC fatal damage.**

The **RX OUT** connector is the output of the transceivers receive path. When the **ADC IN** is enabled, the signal received on the HF path from the active antenna input, goes to the RX OUT. Between the **RX OUT** and **RX IN** connectors may be added an additional filter or box of switched filters, preamplifier, attenuator, signal divider etc.

Note:

•The signal passing through the HF path may be attenuated by the -20dB attenuator, if you set it in the software.

4 CONNECTORS PIN-OUT

4.1 MIC1

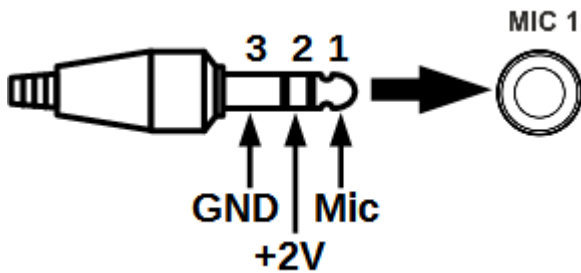

Out #	Output name	Description	Note
1	MIC	Mic signal input	Input
2	+2V	DC 2V supply into the MIC	Output
3	GND	Ground	--

4.2 MIC2

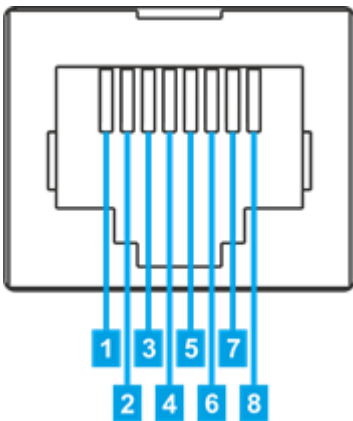

Out #	Output name	Description	Note
1	DWN TNG	Not implemented in the software	--
2	UP TNG	Not implemented in the software	--
3	+5V	DC 5V output with maximum current up to 20 mA	Output
4	MIC_GND	MIC case	--
5	MIC	Mic signal input	Input
6	PTT TNG	PTT signal input Connection of the PTT to the GND will turn the transceiver to the TX mode	Input

7	GND	Ground	--
8	FST TNG	Not implemented in the software	--

4.3 EXT CTRL

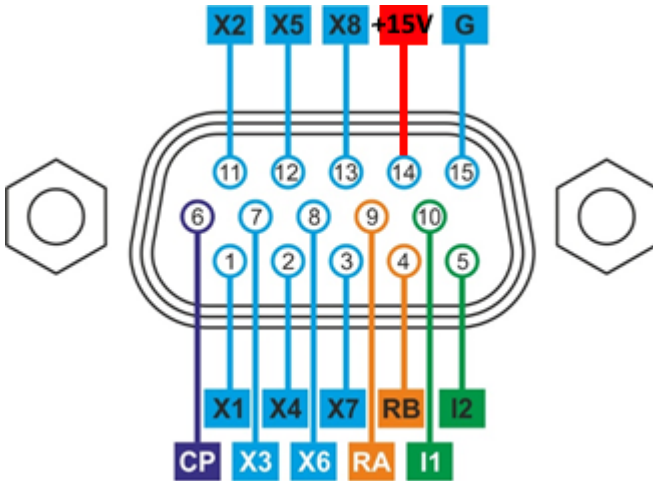

Out #	Output name	Description	Note
1	X1	Programmable key with open collector	Output
2	X4	Programmable key with open collector	Output
3	X7	Programmable key with open collector	Output
4	RB	RS-485 (-) Line	Input/Output
5	I2	Connection of buttoned detector. Connect to ground. In reserve.	Input
6	CP	Contact of protected diode	--
7	X3	Programmable key with open collector	Output
8	X6	Programmable key with open collector	Output
9	RA	RS-485 (+) Line	Input/Output
10	I1	Connection of buttoned detector. Connect to ground. In reserve.	Input
11	X2	Programmable key with open collector	Output
12	X5	Programmable key with open collector	Output

13	X8(PTT)	Programmable key with open collector for control of external PAs PTT	Output
14	+15V	Pin to supply external devices, nominal current 1A There is a 1A fuse integrated in the line - 2A fused	Output
15	GND	Ground	--

Note:

- *When an electronic key with open collector triggers, it leads to key's ground connection. Voltage drop equals 0.7V.*
- *RS-485 interface is reserved.*
- *Logic inputs of the buttoned detectors are reserved.*

Warning!

- ① **Maximum allowed current via electronic keys is 500 mA!**
- ① **While connecting an inductive load (relay, solenoids, fans etc.) to the X1-X8 keys, it's important to connect the protective diode in parallel to the load!**

5 ExpertSDR2 SOFTWARE DESCRIPTION

The basic description of the software interface is presented in the Getting Started guide on our web-site: eesdr.com.

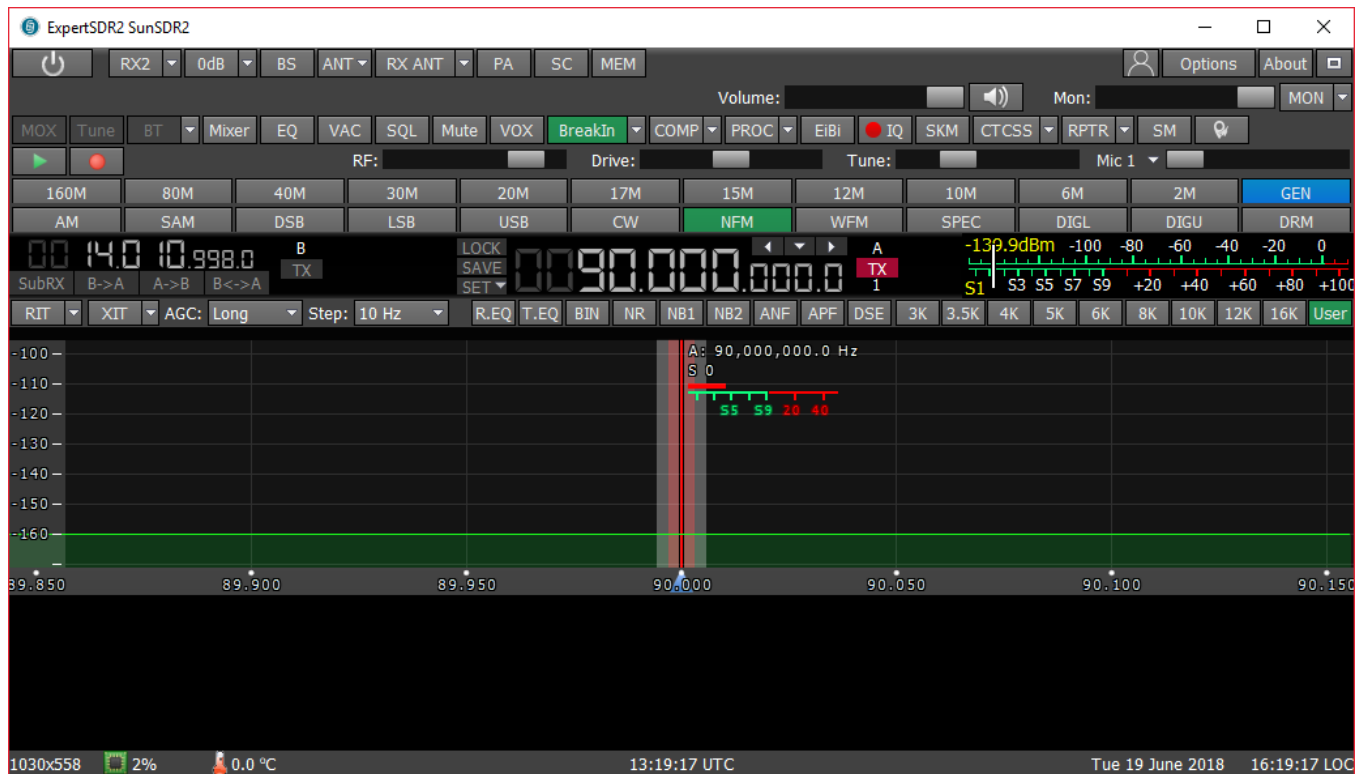

Software settings which won't be mentioned or addressed in this manual, are set by default or provided to the user's self-study and experiments. All the unmentioned settings cannot cause the fatal damage of the SunSDR2 PRO transceiver's hardware, so you can safely experiment with them. You're dealing with the software-defined radio - SDR, the main settings and signal processing are held in the software.

5.1 Global controls panel

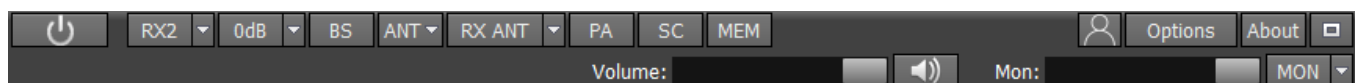

This panel consists of the following buttons:

 - the **Start** button switches on/off the ExpertSDR2 software.

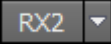
 - enable/disable button of the second software receiver (**RX2**).

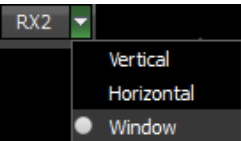
 - In the **RX2** drop-down menu, you can select receiver's window configuration.

RX2 window has the same interface as the **RX1**.

Note:

•Two independent software receivers can operate simultaneously only in one Nyquist zone 0-80 MHz or 80-160 MHz.



- **Attenuator** level can be set via the drop down menu or by successive presses of the indicator button, which cycles upwards the attenuation coefficient in the following order: -20dB, -10dB, 0dB, +10dB.

Note:

•While using Band Pass Filters (BPFs), the attenuator and the preamplifier values are stored for each filter and each band accordingly. When the Low Pass Filter (LPF) is enabled for the whole HF band, its attenuator/preamplifier level is already stored.

•When you use BPFs along with the **RX2**, the filters are controlled by the **RX1**.

•**Attenuator specifics:** S-meter values and audio level have program compensation when you use the attenuator because signal level on the antenna input is always the same and doesn't depend on the attenuator level. With this solution, a user doesn't need to calculate real values on his own, every time when the -20 dB attenuator is used. Also, he doesn't need to adjust AF or RF level every time when the -20 dB attenuator is used, like in most classic transceivers.

Attenuator influences only receiving dynamic range, S-meter and audio level stay the same. If you disconnect antenna you can see how receiver's noises are changing when you switch the ATT. Receiver's noise level is lower when you select ATT 0 dB, it means that RX sensitivity is higher, but RX noise level is higher when you use ATT -20 dB, it means that RX sensitivity is worse. It is done in the hardware.



- enable/disable the wide **bandscope** in the same Nyquist zone as the **RX1**, from 0 to 80 MHz or from 80 to 160 MHz (**BS**).

When you use the **bandscope**, Band Pass Filters are still active, to use the WideRX filter (0-65 MHz or 95-155 MHz) set the **Use wide RX filter** checkbox or **Auto enable** checkbox (it will turn the Wide RX filter automatically) in the Options > Device menu.

The **bandscope** window can be either adjusted inside the ExpertSDR2 window or can be displayed as the separate window on the second monitor. Navigation and settings of the **bandscope** are similar to the panorama settings of the main receiver.

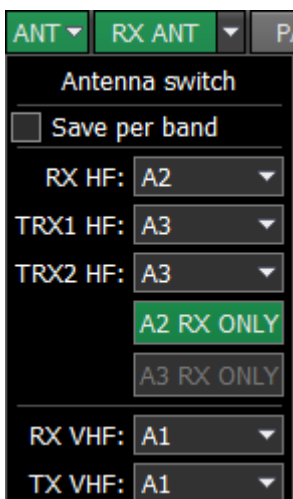

- **Antenna switch** menu. This menu allows you to lock the required HF/VHF antenna input **only for RX**. When the certain HF/VHF antenna input is locked for RX you cannot select it for TX.

For more details on the [antenna switch](#)^{D89} operation.

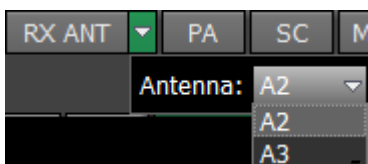

RX ANT button enables receiving on the selected antenna input, which is selected in the drop-down menu. You cannot select the antenna input as **RX ONLY** if it's selected for TX.

PA - enable/disable an external power amplifier (**PA**).

SC - enable/disable sound output from the PC's sound card (**SC**). It doesn't prevent sound output from the front panel, it duplicates output from the PC's sound card.

MEM - enable/disable button of the frequency memory panel (**MEM**).

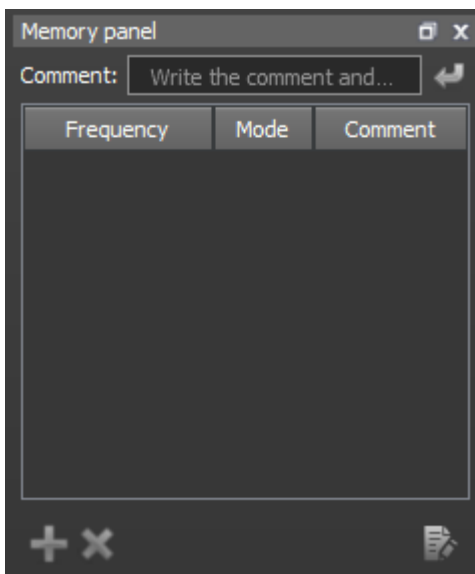

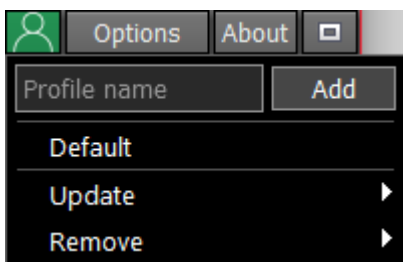

- In the **Profile** manager menu you can:

- add a new profile, by entering the name of the profile in the “Profile name” field and pressing **Add** button.
- set the settings of the whole program to the default state, by the **Default** button.
- **Update** the settings of the certain profile from the list to the current settings.
- **Remove** the certain profile from the list.

Note:

• All new profiles will be stacked up to the drop-down menu as a new line.

Options - **Options** menu described [options](#)⁴⁸.

About - **About** button opens the new window with the info about current version of the ExpertSDR2 software:



Fullscreen - pressing the **Fullscreen** mode button will unfold the software window on the whole screen.



- **Volume** slider. This setting is stored per band, it affects the LF output on the transceiver’s front panel and PC’s sound card output. Speaker icon has the mute function.



- **Mon** volume slider. Press the **MON** button to enable the monitoring. This function allows you to listen to the generated signal and control its quality.

Note:

•An excessive monitoring volume may lead to the positive acoustic connection between the microphone and headphones and as a result to the self-triggering of the audio path.

•In CW mode, transceiver always generates monitoring signal, even if the MON button is not pressed, you use it while working on the air. BUT, if the MON button is not pressed, TX signal won't be displayed on the panorama. To display your TX CW signal press the MON button.

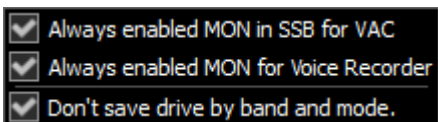

- Even if the **MON** button is switched off, it is possible to enable the following functions from the drop-down menu:

Always enabled MON in SSB for VAC: if the audio record is transmitted in SSB via VAC, the self-control will be enabled.

Always enabled MON for Voice Recorder: if the voice recorder is transmitting the audio record, the self-control will be enabled.

Don't save drive by band and mode: disables saving of the **Drive** level per band and mode.

Note:

•If the checkbox is not set, **Drive** level is memorized for the frequency bands and mode types. **Tone** level is memorized only for the frequency bands.

5.2 Software transceiver settings

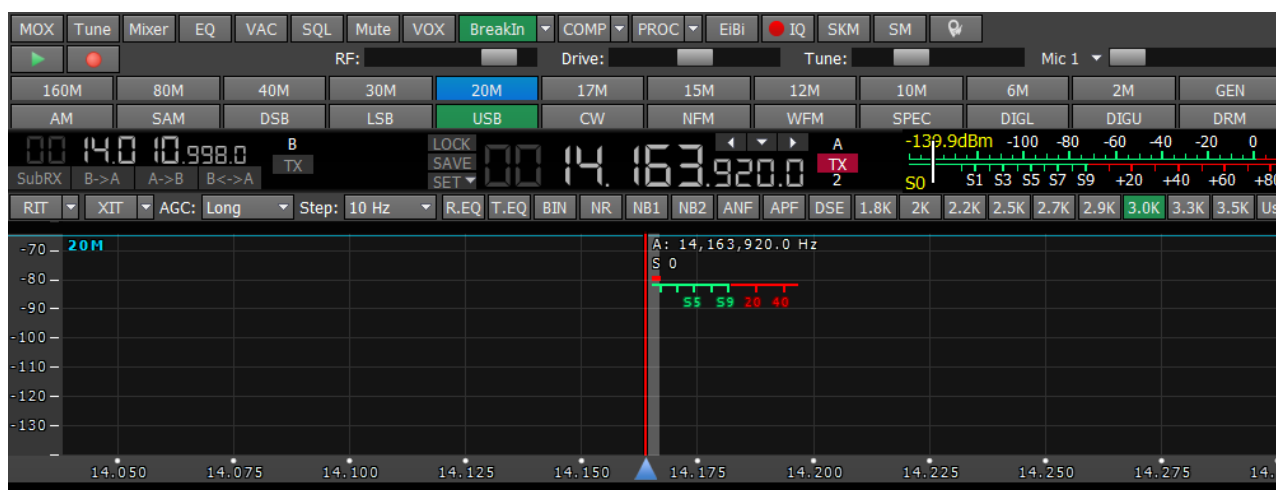

These settings are divided into four logical parts, described below.

5.2.1 Transceiver control panel

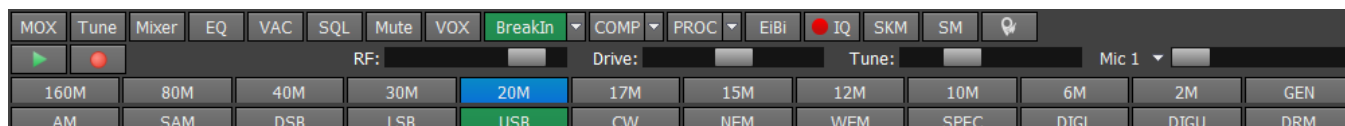

MOX - enable/disable manually operated transmit mode (**MOX**).

Tune - enable/disable tone (carrier) signal in TX mode, the output power can be adjusted by the **Tone** slider (**Tune**).

Tune: 

Mixer - volume and balance control menu for the first and second receivers separately (**Mixer**). When you use only RX1, the Mixer settings are off, but when you enable the RX2, it activates Mixers for both RXs.

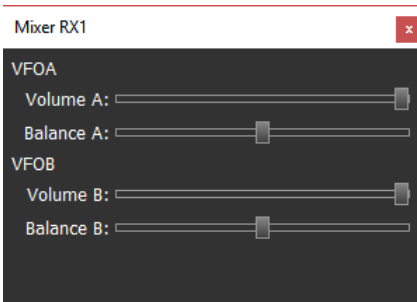

EQ - open the 18-band RX equalizer menu (**EQ**).

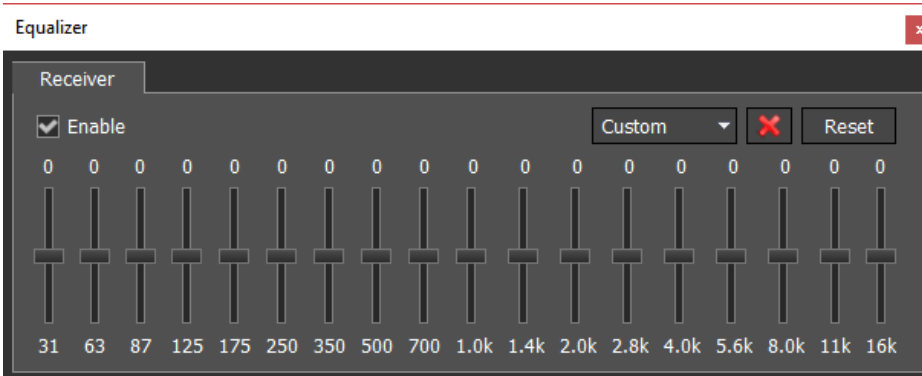

VAC - button enables the **VAC** (data exchange via Virtual Audio Cables).

SQL - button enables the squelch (**SQL**). Displayed as the vertical yellow needle on the S-meter. If the air signal - green needle, surpasses the SQL trigger threshold - yellow needle, then you'll hear the sound of the receiving station on the receiver's LF output. If the signal level is lower than the trigger threshold, you'll hear nothing.

Mute - button mutes LF signal (**Mute**).

VOX - (Voice Activated Transmit) button switches the transceiver in TX mode when you speak in the microphone, more details [here](#)⁵¹ (**VOX**).

BreakIn - transceiver will automatically turn to the TX mode by the press on the CW keyer (**BreakIn**).

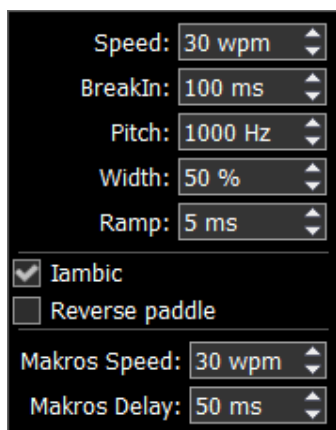

- drop-down menu with CW settings:

Speed - the speed of the CW signal being sent.

BreakIn delay (ms) - timing control, to keep the transceiver in the TX mode. Set the required time for the transceiver to hold in the TX mode after you let go of the CW keyer.

Pitch (Hz) - CW signal's frequency tone control. Set the required CW signal's frequency tone (also used for the RX mode).

Width (%) - Dot-to-pause ratio. Width value 50, means that Dot equals pause in length. Dash always equals 3 Dots.

Ramp (ms) - CW signals' slope length control. Set the required CW signals' slope length. The higher manipulation speed, the shorter should be slopes.

Iambic - enable/disable automatic dots and dashes generation. If the IAMBIC mode is off, while you press the CW keyer it will generate tone signal with PITCH frequency.

Reverse paddle - enable the checkbox to generate dots and dashes in reverse order.

Macros Speed - speed of CW macroses generation via TCI interface.

Macros Delay - CW macroses generation delay after switch from RX to TX, via TCI interface.

When you enable the BreakIn you'll see the following message in the Status bar:

WARNING! PTT switching delays are disabled in CW mode, and with CW manipulation in SSB! Be careful using an external PA!

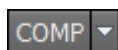

- turns on the compression of the transmitted signal (**COMP**).

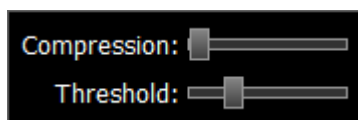

- Via the drop-down menu, you can adjust the compression and threshold levels.

Note:

•Set the MIC AGC gain, that the microphone signal is increased to the level of -10...-5 dB on the MIC-meter indicator (green bar).

Mic Gain and Compression settings:

1. Set the Meter to the Mic-meter mode in the Desktop style (right click on the S-Meter->TX->Mic-meter).
2. Set the Drive level to 0.
3. Enable the TX mode and speak in the microphone.
4. Increase the Mic gain from 0 dB till the Mic meter readings will reach -10...-5 dB in peaks.
5. If required enable the compressor.
6. Set Compression to 2-5; set COMP threshold to \sim -30 dB. This level should be more than room noises for about 10-15 dB.

PROC ▾ - enable the microphone signal processing menu (PROC). Profile adjustment in this menu is similar to the global profile menu:

- add a new profile, by entering the name of the profile in the “Profile name” field and pressing Add button.
- Update the settings of the certain profile from the list to the current settings.
- Remove the certain profile from the list.

Note:

• All new profiles will be stacked up to the drop-down menu as a new line.

It consists of the following functions:

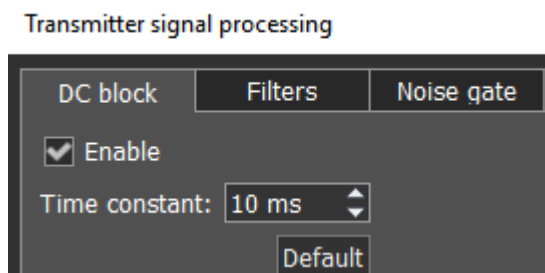

DC block's purpose is to effectively remove **Time constant** in the microphone signal. Changing of **Time constant** influence quality of the applied filter. You can test it by increasing or decreasing **Time constant** value in 1-10 ms range, you'll notice low frequencies reduction with 1 ms value and amplifying with 10 ms value.

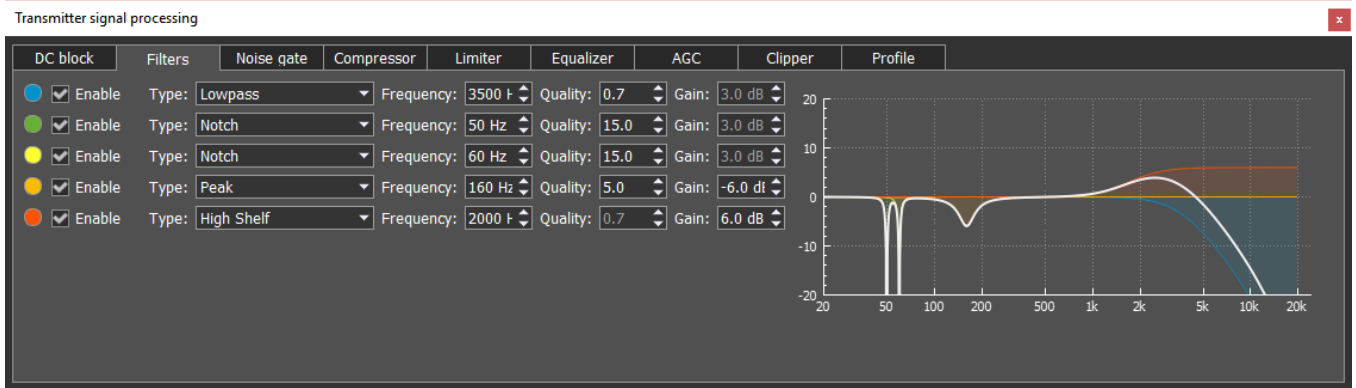

Parametric filter module with graphic display of the summed AFC (amplitude-frequency characteristic - white line) and AFC of each filter. Simultaneously you can use up to 5 filters. Available filter types:

Lowpass - Low Pass Filter (LPF). This filter passes signals with a frequency lower than a certain cutoff frequency. Cutoff frequency is determined by **Frequency**. **Quality** determines steepness of the filter slope.

Highpass - High Pass Filter (HPF). This filter passes signals with a frequency higher than a certain cutoff frequency. Cutoff frequency is determined by **Frequency**. **Quality** determines steepness of the filter slope.

Bandpass - this filter passes frequencies within a certain range (band) and rejects frequencies outside that range. Cutoff frequency is determined by **Frequency**. **Quality** determines bandwidth of the passband.

Notch - it is a band-stop filter with a narrow stopband. It rejects a specific range of frequencies and passes all the other frequencies unaltered. Tuning frequency is determined by **Frequency**. **Quality** determines the stopband bandwidth.

Peak - also known as bell filter. This filter has similar functionality with the Notch filter, but has more flexible settings. It boosts or cuts the chosen frequency by **Gain** value, affecting the surrounding frequencies in a bell-shaped curve. Tuning frequency is determined by **Frequency**. **Quality** determines the cutoff bandwidth.

Low Shelf - this filter cuts or boosts signals of frequencies below the cutoff frequency, determined by **Frequency**. **Gain** value determines attenuation or boost level of frequencies below the cutoff frequency. Frequencies above filter's AFC will not be altered.

High Shelf - this filter cuts or boosts signals of frequencies above the cutoff frequency, determined by **Frequency**. **Gain** value determines attenuation or boost level of frequencies above the cutoff frequency. Frequencies below filter's AFC will not be altered.

Transmitter signal processing

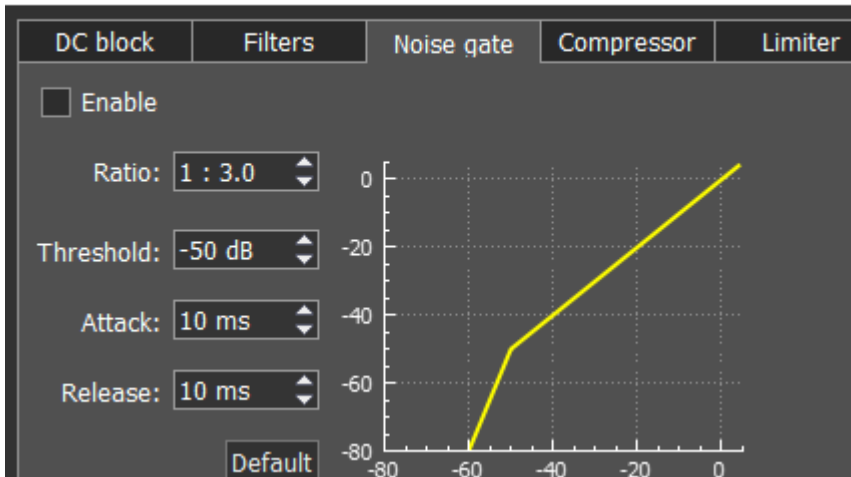

Noise gate or **gate**, removes signals below **Threshold** level. Usually it is used to reduce the noise in pauses.

Gate passes signal only when it's level is higher than set **Threshold**: gate is open. If the signal is lower than set **Threshold**, gate will not pass it (or significantly attenuate): gate is closed. **Gate** should be used when the level of the desired signal is higher than the noise level. **Gate's** level is set higher than the noise, so when there is no desired signal (higher than Threshold) gate is closed. **Gate** does not cleanse the signal from noises. When the gate is open, both signals get through, useful signal and noise.

Parameters:

Ratio - attenuation value, when **Gate** is closed. Usually this parameter is set for full rejection, i.e. signal does not pass through **Gate**, when it's closed. But sometimes you might require a mild rejection in this case adjust **Ratio**.

Threshold - it sets the level for **Gate** to open - pass the useful signal. It supposed to be set above the noise level, but below the useful signal level.

Attack - it sets time (ms), required for **Gate** to change state from closed to fully opened. If **Attack** time is short, as soon as the signal level goes higher than **Threshold**, it creates a sharp noise, longer **Attack** time creates a smooth transition from closed to opened state, but because of it, you may miss first sharp characters, like T, K.

Release - it sets time (ms), required for **Gate** to change state from opened to fully closed. If **Release** time is short, as soon as the signal level goes lower than **Threshold**, it creates a sharp noise, longer **Release** time creates a smooth transition from opened to closed state, it may sound like fading.

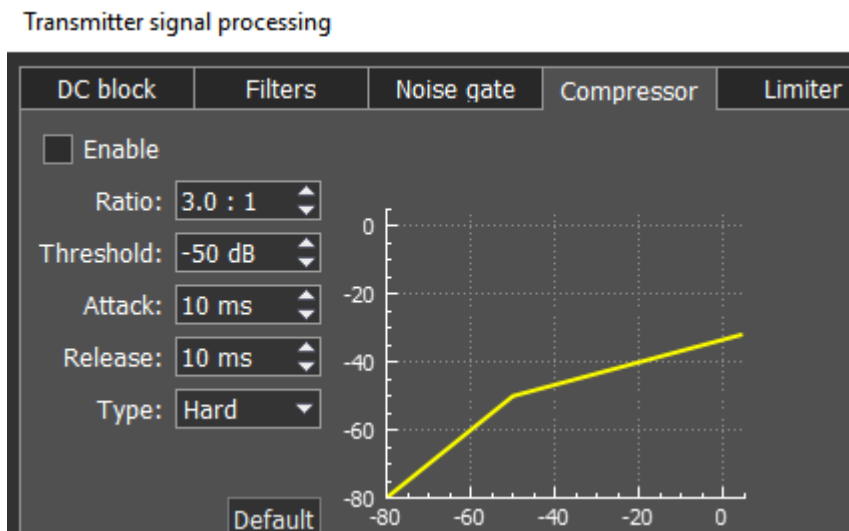

Compressor - is used to reduce

dynamic range of the audio signal, in other words, compressor reduces the difference between the quietest and the loudest sounds.

Compressor automatically controls the volume. Downward compression reduces loud sounds over a certain **Threshold** while quiet sounds remain unaffected.

Compression may improve sound audibility in loud places, where background noises may suppress quiet sounds. While loud sounds will be easily audible, quiet sounds won't be audible, and if you'll increase overall volume, it will improve the situation for quiet sounds, but loud sounds will become unbearable. If you'll apply the downward compression to this audio, the overall volume may be increased to the level when both quiet and loud sounds will be comfortable to listen.

Parameters:

Ratio - determines the ratio of input/output signals which exceed **Threshold**. For example, ratio of 3:1 means that if input level is 3 dB over the threshold, the output signal level is 1 dB over the threshold.

Threshold - a compressor reduces the level of an audio signal if its amplitude exceeds a certain threshold. It is set in decibels dB.

Compressor may be adjusted in a way how fast it reacts:

Attack - this is the period, when the compressor is decreasing volume to reach the level that is determined by **Ratio**. It is activated when the signal exceeds **Threshold** and, if each consecutive signal has higher volume than the signal before it.

Release - this is the period, when the compressor stops compression, increasing signal volume to the default level. It is activated right after **Attack** period is finished. Each time, when after the compressed signal goes the next one, which is lower than **Threshold** or higher, but lower than the compressed one before it, then instead of **Attack**, **Release** is applied for each consecutive signal like this one and compressor stops compression according to **Release** settings. Whether there will be a compression or not while **Release period**, depends on the set time. If in **Release period** signal is compressed, it is compressed with the same Ratio (dB) as the signal before it. Only in that case sounds lower than **Threshold** may be compressed.

Attack and Release parameters should be adjusted depending on how frequently signal volume is changing.

Type Soft/Hard knee - controls whether the bend in the response curve between below **Threshold** and above **Threshold** is abrupt (hard) or gradual (soft). A soft knee slowly increases the compression as the level increases and eventually reaches the compression **Ratio** set by the user. A soft knee reduces the audible change from uncompressed to compressed, especially for higher **Ratios** where a hard knee changeover would be more noticeable.

Knee - available only for soft knee, determines the knee smoothness.

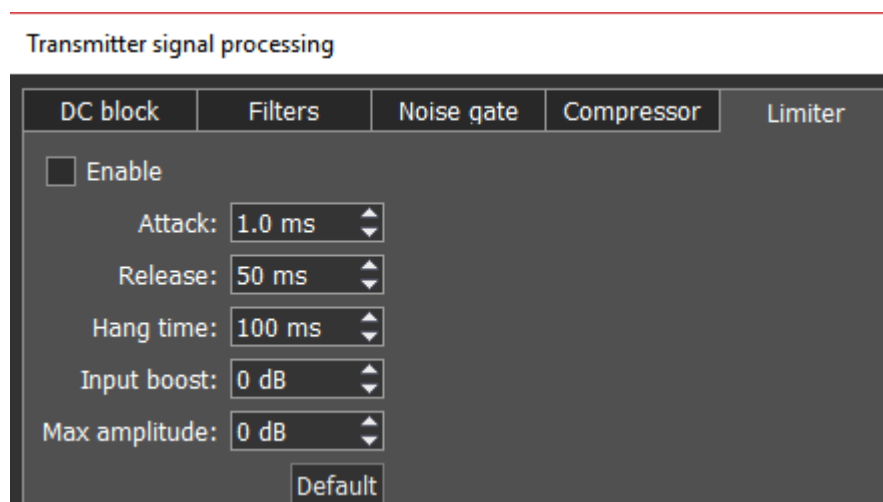

Limiter - is used to limit dynamic range, when signal exceeds **Maximum Amplitude** value. In most cases used to avoid overload (clipping) and suppression of short-term level peaks, while signal dynamic range is being leveled. As a rule, limiter is used along with increasing the input level on the **Input Boost** value, this technique increases overall signal level, while preventing distortion.

Parameters:

Attack - this is the period, when the limiter is decreasing volume to reach the level that is determined by **Max Amplitude**.

Release - this is the period, required for the signal level to be restored to the default value.

Hang time - sets time (in ms) to keep the signal level the same, after **Attack** period is over, before beginning **Release** period.

Input Boost - preamplifying of the input signal before limiter processing.

Maximum Amplitude - sets the signals maximum amplitude on the limiter output.

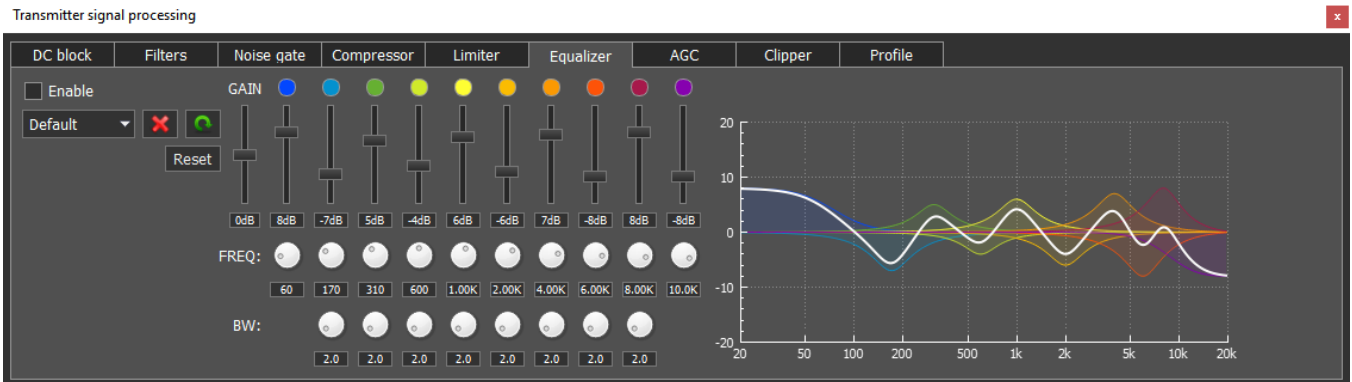

Parametric equalizer module with graphic display of the summed AFC (white line) and AFC of each equalizer. Each equalizer has independent set of controls: the center or primary frequency (**FREQ**), bandwidth (**BW**) and AFC level (boost or cut) - vertical slider. Press right mouse button on any control element to set it to the default value. Thus, using the parametric equalizer you can perform the finest tuning on any required frequency.

In this module, you can find 3 types of filters: **Low Shelf** (on the left), **High Shelf** (on the right), **Peaking** or **Bell** (8 units in between). Their operation is similar to the filters described in the **Filters** module.

Transmitter signal processing

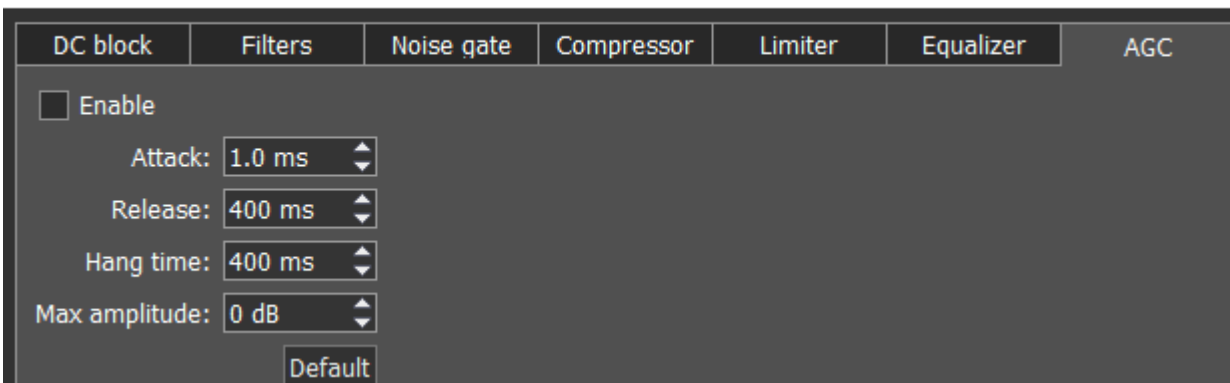
**AGC**

module is responsible for keeping the constant volume level of the Mic signal. Max **AGC** value might be adjusted by the Mic gain on the software front panel. If the Mic signal on the **AGC** input is too weak, then you might need to increase the Mic gain. **AGC** has a delay period which is adjusted by the **Attack**, increasing the **Attack** value will increase delay period.

Parameters:

Attack - signal attenuation period, this value determines how fast **AGC** will decrease the amplitude of the loud signal to the **Maximum Amplitude** value.

Release - signal recovery period, this value determines how fast **AGC** will increase the amplitude of the loud signal to the value which does not exceeds **Maximum Amplitude**.

Hang time - sets time (in ms) to keep the signal level the same, after **Attack** period is over, before beginning **Release** period.

Maximum Amplitude - sets the signals maximum amplitude on the **AGC** output.

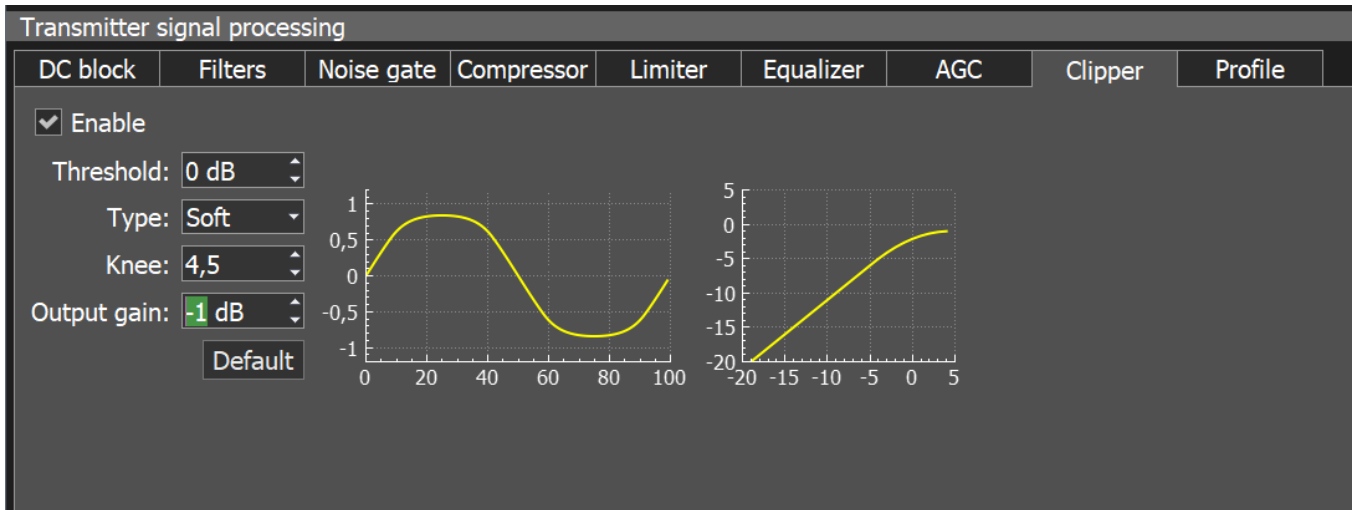

Clipping is a form of waveform distortion that occurs when the output Voltage exceeds **Threshold**. Visually (on oscilloscope) it looks like altered signal peaks, you can hear it as splutters and cracks. **Clipper** reduces signals peak-factor and increases overall power, but distorts the signal.

Parameters:

Threshold - if the signal exceeds this level, **Clipper** alters it, sets in dB.

Type Soft/Hard knee - controls whether the bend in the response curve below **Threshold** is abrupt (hard) or gradual (soft). A soft knee slowly changes the curve towards the clipped signal. A hard knee would be more noticeable.

Knee - available only for soft knee, determines the knee smoothness.

Output gain - you can adjust TX audio signal amplitude after processing, but before modulator.



In the **Profile** tab, you can save settings of the whole TX processing module in a separate module, independent from the main software profile. Load PROC settings from a file by pressing the **Import** button and save a profile in a file by pressing the **Export** button.

To add a new profile, enter unique name in the input box and press the Enter button on your keyboard. You may also delete selected profile, by pressing the - **X**.

Save for each microphone - enable this checkbox to save all **PROC** settings separately for each microphone. E.g. you set your Mic1 settings, then switched to Mic2, changed some

settings then switched back to Mic1, as a result both Mic1 and Mic2 have their own different settings. If this checkbox is unchecked, all **PROC** settings apply for all microphones.

EiBi - show the HF stations markers on the panorama from the EiBi database (**EiBi**). Hover with the mouse pointer on the station frequency and you'll see its name.



IQ - IQ-files recording is required for storing the RX bandwidth panorama (**IQ**). The file is saved to the C:\Users\User_Name\ExpertSDR2\ExpertSDR2\wave\.

SKM - turn on the CW Skimmer, more details in [CW Skimmer](#)^{D80} (**SKM**).

SM - bigger S-meter button (**SM**).

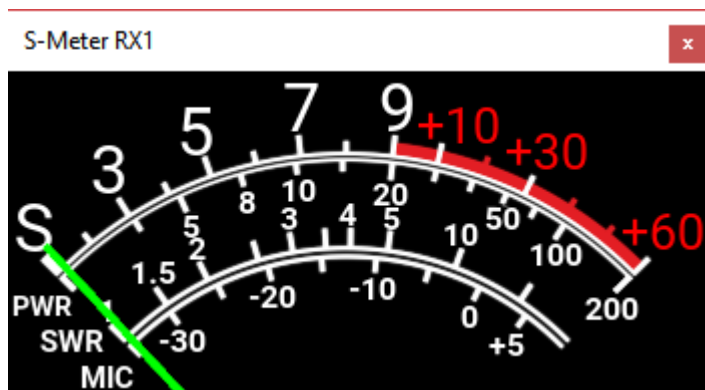

- the S-meter window can be separated from the software window and moved to any place on the screen.

List of the measured parameters:

S-meter - Displays the level of the received signals in the receiver filter bandwidth (in units).

PWR - Displays the level of the output power in TX mode (in Watts).

SWR - Displays the SWR level in TX mode (**blue** bar).

MIC - Displays the level of the MIC signal before modulator (in dBW, **green** bar).

SQL - Squelch trigger threshold for the received signals (**yellow** needle).

 - press this button to clear the panorama of all displayed spots.

When you enable the **NFM** mode, three additional buttons appear:

 - **Burst Tone** button (**BT**). In some cases, repeater stops working after some time - goes to "sleep" mode. To wake it from the "sleep" mode you need to send the Burst Tone of the exact frequency for some time (a common value for tone frequency is 1750 Hz, but can vary in some repeaters).

To form a Burst tone:

1. Set the NFM mode.
2. Set the tone frequency.
3. Set the required tone TX time, enough for the used repeater.
4. Press the **BT** button.

The transceiver will send the FM tone signal with your settings.

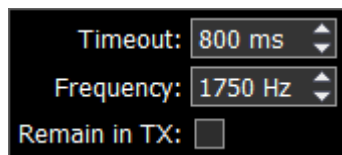

- You may adjust signal **Timeout** and **Frequency** in the drop-down menu.

Remain in TX checkbox - set to stay in the TX mode after the timeout.

 - **Continuous Tone-Coded Squelch System** button. In some cases, it's required to activate the squelch with the help of the **CTCSS** tones.

You set the **CTCSS** level relatively to your voice signal.

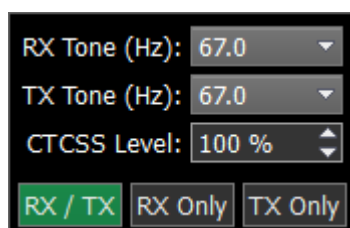

1. Set the NFM mode.
2. Set the receiver's tone frequency in the RX TONE input-box.
 - 2.a. Set the transceiver's tone frequency in the TX TONE input-box.
3. Press one of the buttons RX/TX, RX ONLY, TX ONLY:
 - RX/TX - CTCSS mode is active in RX and TX modes.
 - RX ONLY - CTCSS mode is active in RX mode.
 - TX ONLY - CTCSS mode is active in TX mode.
4. Set (if required) required tone level.

By default, 15% - common value for this mode.

5. Press the CTCSS button to activate CTCSS mode.

6. Receive signals with the CTCSS tone.

6.a. Press the PTT button on the Mic to transmit the signals with the CTCSS tone.

7. Release the PTT button on the Mic to turn to RX mode.

 - button switches the shift of the transmission frequency, to operate through a repeater. This function is usually used on the 10M, 6M, 2M and 70cm bands.

 - in the drop-down window, you can adjust the **Shift** frequency.

Enable the shift of the TX frequency to work through a repeater. The sub-receiver displays the TX frequency and the main receiver displays the RX frequency.

When you enable the **WFM** mode, one additional button appears:

 - when enabled, this function allows the software to automatically detect whether the station is strong or not and lets you listen to it in **stereo** mode.

 - **Play/Record** buttons. More details in the [Voice Recorder operation](#)⁹⁰.

 - **AGC** sensitivity control slider (Automatic Gain Control on classic transceiver). The adjusted level is saved per band.

 - slider for the transceiver's output power adjustment.

 - slider for the transceiver's output power adjustment while transmitting the tone (carrier) signal.

 - slider for the microphone gain level. In CW mode, it switches to the **Speed** button and duplicates the **BreakIn** functionality.

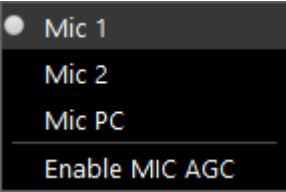
 - In the drop-down menu, you can select **Mic1**, **Mic2** - transceiver's microphones, **Mic PC** - PC's microphone. For fine tuning of the PC microphone open: **Options** > **Mic** tab (more details in the [Mic tab](#)⁴⁹). Also in this menu, you can **Enable Mic AGC**.

Note:

•Remember, if you disable the MIC AGC, it may distort your signal and cause interference to neighboring stations.

A panel of mode buttons:



AM - Amplitude Modulation

SAM - Synchronous Amplitude Modulation

DSB - Double Side Band

LSB - Lower Side Band

USB - Upper Side Band

CW - CW mode. **It works in CW-U for all bands. It cannot be changed.**

NFM - Narrow FM

WFM - Wide FM, supports receiving of the stereo signals

SPEC - Spectrum mode. Receive the pure signal without any demodulation (panadapter bandwidth). The idea is to receive pure signal then pass it to some special device, via a cable connected to the PHONES audio output of the transceiver or PC audio output, with certain demodulation capabilities

DIGL - Digital Lower Side Band. Connect a third-party software (is not supplied) to the transceiver software for operating in digital modes

DIGU - Digital Upper Side Band. Connect a third-party software (is not supplied) to the transceiver software for operating in digital modes

Note:

•To work in digital modes, use DIGL and DIGU. Mic AGC gain, COMP and EQ can distort the TX digital signal, that's why they are automatically disabled in these modes. Also in DIGL and DIGU modes, you can save your TX and RX filter width.

DRM - Digital Radio Mondiale, 10 kHz filter with 5 kHz IF to work with the external decoder of the DRM signals. Connect third-party software (is not supplied) to the transceiver software for decoding of the DRM signals



160M - 2M - amateur bands

GEN - if out of the amateur bands

5.2.2 Frequency and S-meter indicators

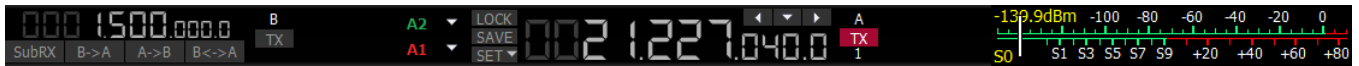

Mainly, this panel consists of the visual indicators, like the VFO A/B frequencies, the signal level on the antenna's input (S-meter) and several control buttons.

Displaying elements:

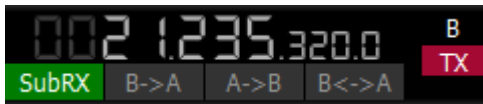

- VFO B frequency indicator (sub-receiver).

Note:

•You won't hear the audio from the VFO B if it is out of the panorama bandwidth.

Sub-receiver control unit:



SubRX - enable sub-receiver. If you want to listen to the VFO A and VFO B frequencies simultaneously, use the Sub-receiver.

1. Activate the Sub-receiver by pressing the **SubRX** button.
2. Set the required VFO B frequency.
3. Listen to the VFO A and VFO B frequencies simultaneously.

Note:

•VFO A receiver's red tuning line means that in Sub-RX mode you'll transmit on the VFO A frequency.

↳To turn the Sub-receiver to transmit, press the **red TX button/indicator**.

↳You can switch the point and click control on the panorama between VFO A and VFO B receivers, by pressing the middle mouse button. You'll control the RX with the same color to the mouse cursor.

↳When you change the band the **SubRX** is disabled.

B>A - assign the VFO B frequency to VFO A

A>B - assign the VFO A frequency to VFO B

B<>A - swap frequencies between the VFO A and VFO B

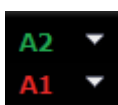

- Antenna switch indicator. It displays which antenna input is used for RX and TX.



- VFO A frequency indicator (main receiver).

Main receiver control unit:



LOCK - lock the VFO A frequency tuning.

SAVE - save the current VFO A frequency and mode type in the memory panel.

SET - manual frequency input for VFO A or VFO B.

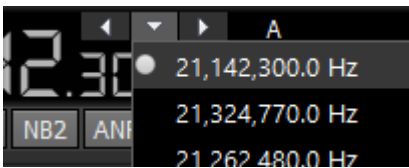

- **Navigation buttons**. The quick memory cells are automatically stored with the frequencies if the receiver stands still over a second. Then those frequencies can be selected in order back and forth, as in an internet browser. The total stack contains 16 cells.



- **Band Stacking Memories** indicator (VFO A only). Each memory slot has a frequency, mode, and filter settings. Each band has three memory slots associated with it. Successive presses of a band button will cycle through the stored memory slots. It might be useful for quick frequency and mode changes within a band. To replace one memory slot:

1. click the required band button you would like to modify.
2. change the frequency (within a selected band), mode, and filter to the required settings.
3. click the band button again to save the values.

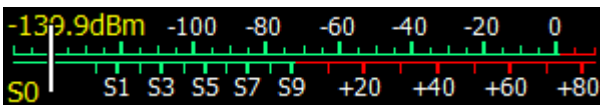

- **S-meter** - by default this scale displays the power level of the signals in the RX filter bandwidth. The scale has two grade types: in S-units and in dBm. The signal strength displayed in dBm to mW (yellow figure) in the top left corner of the S-Meter. In the TX mode, the output power is indicated in W and antenna's SWR.

Note:

•S-Meter in the ExpertSDR2 has two different calibrations for HF (0-30 MHz) and VHF (30-300 MHz). HF and VHF signals with the same dBm level have different S-scale values. For example: HF S9 = -73 dBm = 50 uV (50 Ohm), VHF S9 = -93 dBm = 5 uV (50 Ohm). S-Meter in the ExpertSDR2 corresponds to the IARU recommendations, each device is calibrated at the manufacturing.

Click the right mouse button on the S-meter and select the display type for RX or TX:

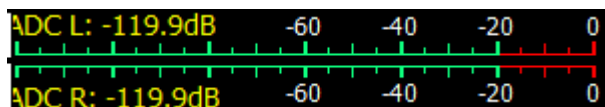

- ADC type displays the power in each quadrature channel (double scale) in RX mode.

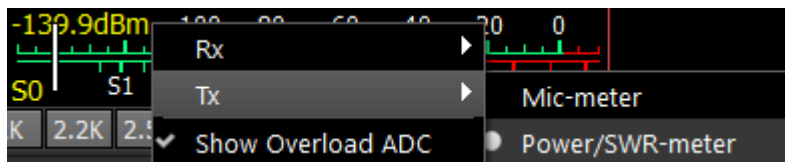

- In the TX mode, the MIC-meter type shows the microphone's signal level. In the Power/SWR-meter type, the power indicator and SWR will be displayed.

5.2.3 DSP control panel

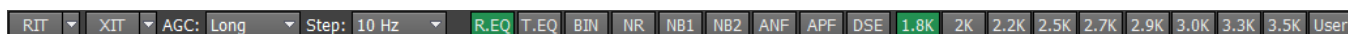

RIT - Receive Incremental Tuning.

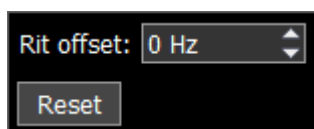

- In the drop-down menu, you can set the frequency offset in Hz. **Reset** - resets the offset value to zero (more details in [RIT](#)⁹²).

XIT - Transmit Incremental Tuning (more details in [XIT](#)⁹³).

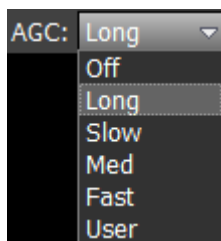

- **AGC** presets menu. In the drop-down menu, you can select the receiver's AGC preset:

OFF - AGC is off.

LONG - preset with long AGC reaction (approximately 750 ms). Recommended for phone modes.

SLOW - preset with slow AGC reaction (approximately 500 ms). Recommended for phone, digital modes.

MED - preset with medium AGC reaction (approximately 250 ms). Recommended for CW, digital modes.

FAST - preset with fast AGC reaction (approximately 100 ms). Recommended for CW, digital modes.

USER - preset with custom AGC reaction (by default the slowest 1000 ms).

Note:

•AGC settings influence the quality of the received signal. Be careful selecting the AGC preset or tuning your own preset.

Step: 10 Hz ▾ - **Step** list allows to change the step of the **mouse wheel** in the range from 0.1 Hz to 100 kHz.

DSP functions:

R.EQ - enable the RX equalizer (enabled on the picture).

T.EQ - enable the TX equalizer.

BIN - binaural audio mode (the phasing of the audio signal within the RX filter gives a stereo-like effect).

NR - enable the adaptive Noise Reduction to clean the signal from noise interferences.

NB1 - enable the First Noise Blanker for impulse interference.

NB2 - enable the Second Noise Blanker for impulse interference.

Note:

•The NB1 and NB2 algorithms are different. Try each of them to reach the best impulse interference reduction. NB1 and NB2 Noise Blankers can be used simultaneously.

ANF - enable Automatic Notch Filter for adaptive rejection of the narrowband interference in the receiving band (interference, carrier signals, CW signals, etc.).

Note:

•If there are no interference, ANF could slightly affect the reception quality of the desired signal. Disable ANF, if you don't need it.

APF - enable Analog Pick Filter, it creates the triangle filter's AFC (amplitude-frequency characteristic) in the filter bandpass.

Note:

•When filter BW is lower than 200 Hz, there is no point in APF, thus it is switched off automatically.

DSE - enable Digital Surround Effect for CW signals, it provides a space orientation in stereo phones.

Note:

- This algorithm provides panorama acoustic of the CW signals in the filter bandwidth, depending on their position in the filter:

if the received CW signal is in the receive filter bandwidth and lower the tuned frequency, it will be louder in the left phone;

if the received CW signal is in the receive filter bandwidth and higher the tuned frequency, it will be louder in the right phone;

if the received CW signal is in the receive filter bandwidth and in the middle of the tuned frequency, it will be equally loud in both ears.

RX filter bandwidth presets. Presets list depends on the mode type:

3K 3.5K 4K 5K 6K 8K 10K 12K 16K User - AM, SAM, DSB, NFM modes (3 - 16 kHz);

1.8K 2K 2.2K 2.5K 2.7K 2.9K 3.0K 3.3K 3.5K User - LSB, USB, DIGL, DIGU modes (1.8 - 3.5 kHz);

50 100 250 400 500 650 800 1000 1200 User - CW mode (50 - 1200 Hz);

50K 80K 110K 120K 150K 180K 240K 280K 310K User - WFM mode (50 - 310 kHz);

10K - DRM mode (has one fixed bandwidth 10 kHz);

User - user can adjust the RX filter bandwidth by himself (available at any modulation type except DRM).

5.2.4 Panorama description

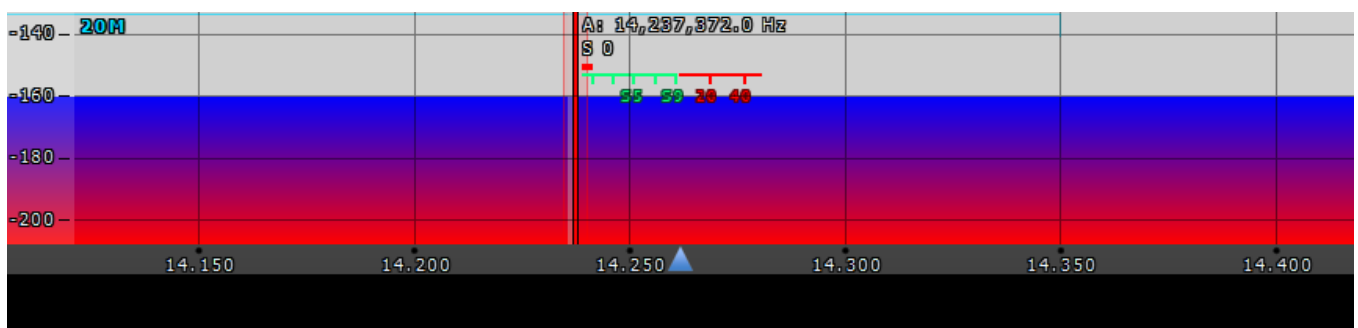

The panorama consists of two parts separated by the horizontal scale: 1) Spectrum Scope and 2) Waterfall.

5.2.4.1 Spectrum Scope

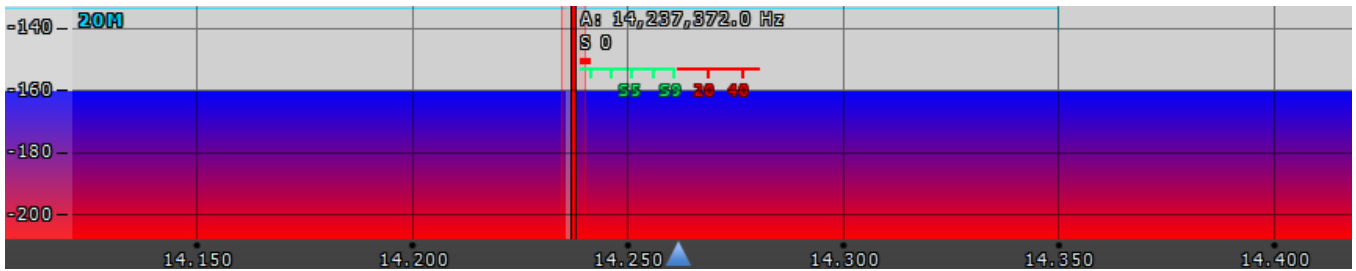

In this window, you can see the spectrum, with the sample rate from 39 up to 312 kHz (adjustable by User) and the RX filter to tune and listen to the stations.

There is a vertical scale on the left side of the spectrum scope, it indicates the power level of signals in dBm. Amateur band indicator displayed as the blue line on top of the graph with the name of the band, it shows the limits of the amateur band.

RX/TX filter position is indicated by the vertical red line. To the right of the line indicated its precise tuning frequency (can be switched off in Options). Below the frequency, you can see the signal level on the S-Meter scale (can be switched off in Options). RX filter bandwidth displayed as the translucent gray area around the tuning frequency. You can listen to everything within this band.

Spectrum is displayed as a line on the spectrum scope, but it also may have a filling color. You can change spectrum rendering mode, line color, filling color, transparency, etc. in the software Options (more details in the [Spectrum tab](#)⁶⁴).

5.2.4.1.1 Spectrum Scope scaling

If you move the mouse cursor over the vertical scale a hand will appear. Press and hold the right mouse button, then move it up/down to change the dBm scaling or press and hold the left mouse button, then move it up/down to change the spectrum level.

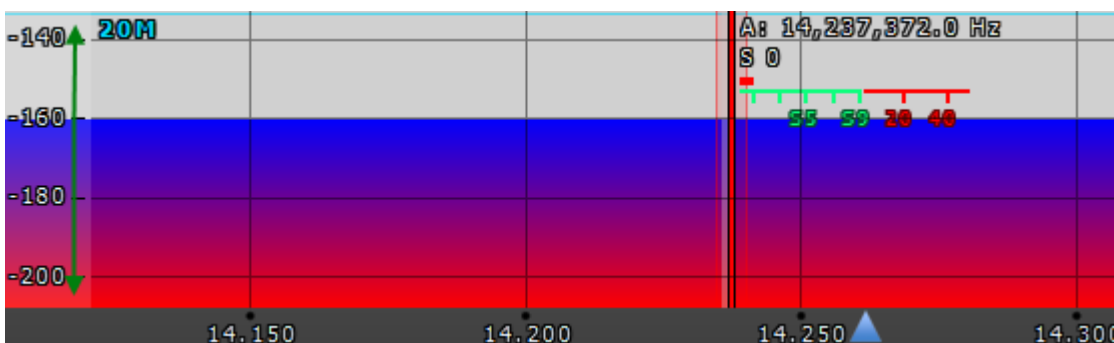

The horizontal scale between the spectrum scope and waterfall shows the frequency of the certain point on the spectrum. If you move the mouse cursor over the horizontal scale a hand will appear. Press and hold the right mouse button, then move it left/right to zoom in/out the panorama or press and hold the left mouse button, then move it up/down to change the ratio of the spectrum to waterfall.

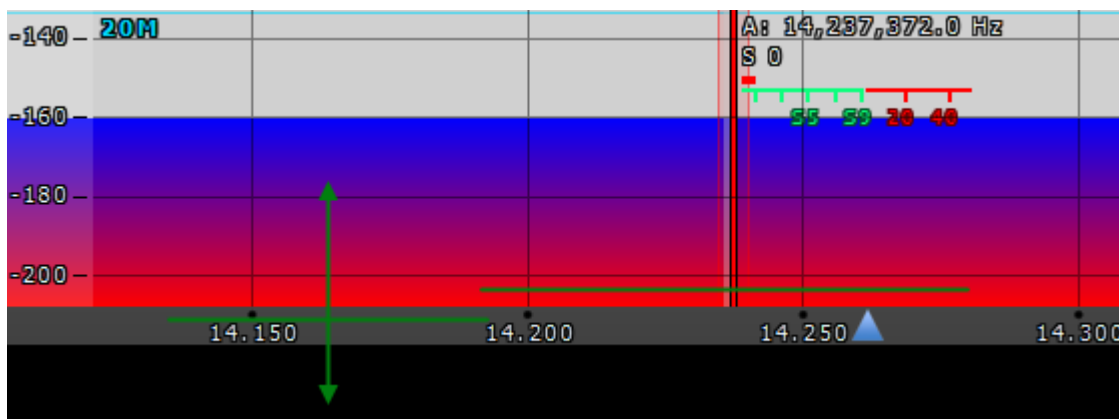

Zoom in/out of the panorama is carried out relative to the **Zoom position** marker.

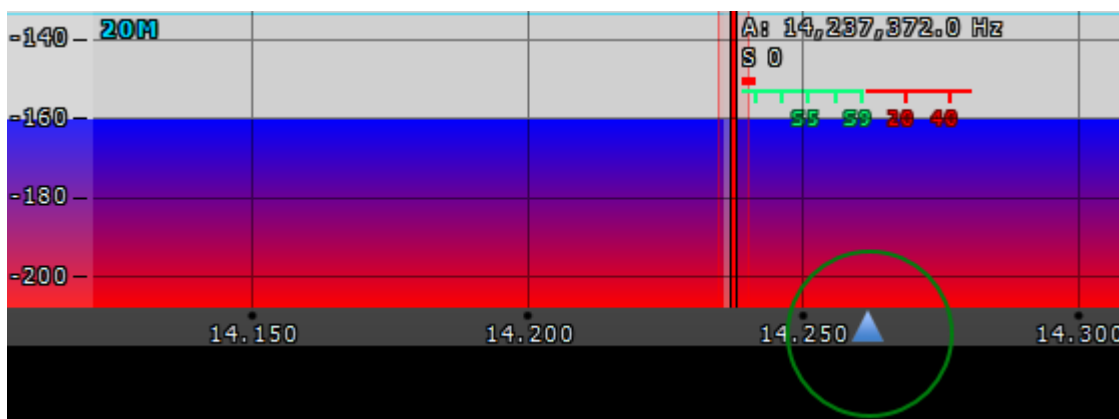

There are two ways to change the **Zoom position**:

1. Press and hold the left mouse button on the **Zoom marker** and drag it left/right,
2. Click the mouse wheel on the frequency scale.

5.2.4.2 Waterfall

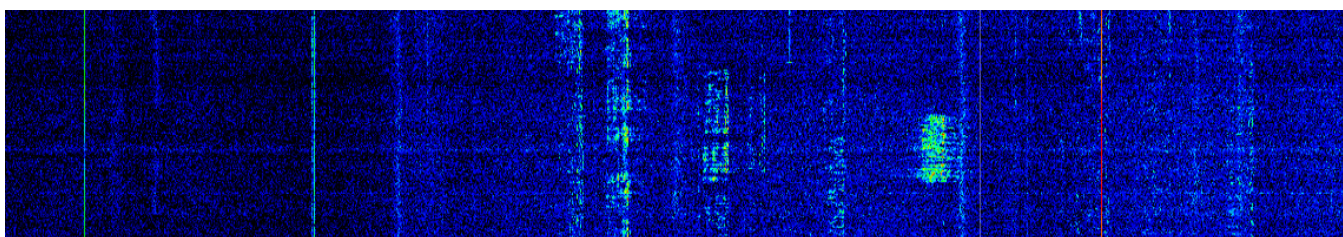

Waterfall graphic - timed spectrum scope in the format: amplitude - brightness, frequency - horizontal, time - vertical. The comfortable settings are set by default, but you can change them if necessary (more details in [Waterfall tab](#)⁶⁷).

5.2.5 Status bar

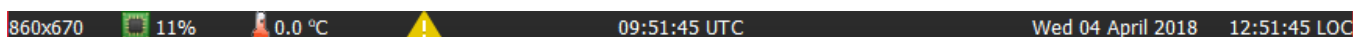

The status bar displays the following information (from left to right):

- ExpertSDR2 window size in pixels.
- CPU load in percent.
- The temperature inside the transceiver.

- **Yellow** warning triangle, in case you've enabled the **BreakIn** with CW or SSB mode.
- Coordinated Universal Time (UTC).
- Current date and Local Time.

5.3 Options

For fine tuning of the ExpertSDR2 software press the **Options** button in the top right corner of the software window.

Note:

✦ If you changed anything in the menu and you don't like it, but you forgot the default value, you can reset all setting to default values by simply clicking the **Global Default** button.

✦ You can check the changes without leaving the **Options** window, just click the **Apply** button.

✦ If you are satisfied with the changes and don't want to change anything else, click the **OK** button to close the **Options** window.

Warning!

- ① **We recommend you study this section of the manual very carefully because many settings are hidden in the sub-menus.**

5.3.1 Device menu

In the **Device** menu, you can find software functions of the signal processing and hardware settings.

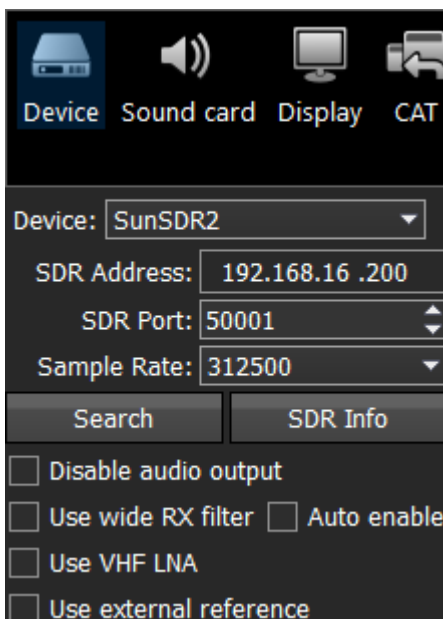

Device - device type menu. Shows that the ExpertSDR2 software works in the SunSDR2 PRO mode.

SDR Address - physical static IP-address of the SDR module, locked at 192.168.16.200.

SDR Port - port number, which is used for the data exchange, locked at 50001.

Sample Rate - IF sample rate, equals the panorama bandwidth. You can select one of four panorama bandwidth values.

Search - search the device in the local network. When you press the **Search** button, software searches for the SDR-device in the network.

SDR Info - button to show you the transceiver serial number, firmware revision, PCB revision and set options.

Note:

•You can use this button to test the connection between the software and SDR module. If the connection is successfully set up - you'll see the transceiver's info, if not - nothing will show up.

Disable audio output - turns off transceiver's audio output from the headphones connector.

Use RX Wide filter - set the Use RX Wide filter checkbox to enable the wide filter for the whole HF (0...65 MHz) or VHF (95...155 MHz) band.

Auto enable - set the Auto enable checkbox to auto enable RX WF when the band-scope and/or the second receiver on the other band are switched on.

VHF LNA - set the VHF LNA checkbox to auto enable Low Noise Amplifier for the VHF band.

Use external reference - set this checkbox to enable **REF input** on the rear panel of the transceiver and synchronize it with the 10 MHz reference oscillator.

5.3.1.1 Mic

There are two microphone settings categories in the **Mic** tab: **PC Microphone**, **AGC**.

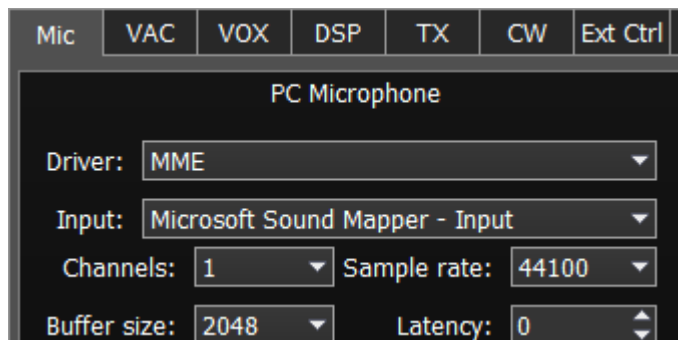

In the PC Microphone category, you can adjust the internal PC's sound card, which is connected to the microphone.

PC Microphone category consists of the following items:

Driver - select the sound card's driver type.

Input - select the sound card's physical input.

Channels - select the amount of the sound card's used channels.

Sample rate - sampling frequency.

Buffer size - size of the buffer.

Latency - signal delay time.

5.3.1.2 VAC

If the ExpertSDR2 and digital modes software run on the same computer, they can be connected via a virtual audio cable without wires and sound cards.

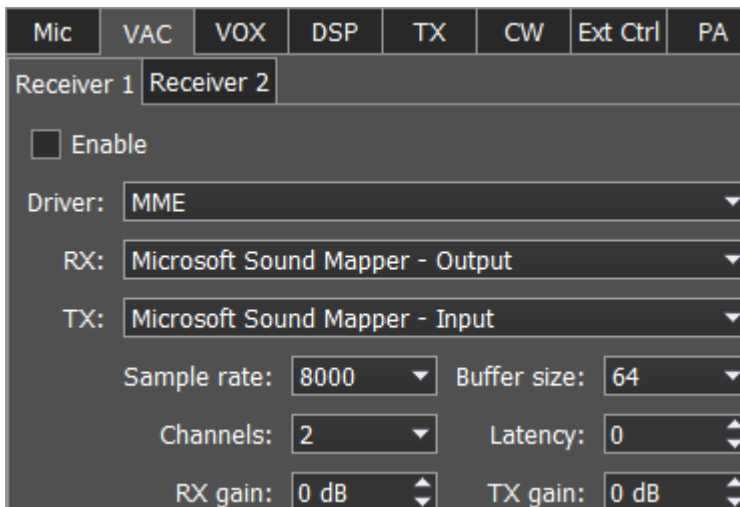

For each program receiver (RX1, RX2) you can set the virtual audio cable on the corresponding tab **Receiver 1** and **Receiver 2**.

Enable - set the Enable checkbox to enable virtual audio cable.

Driver - select the audio cable's or sound card driver type.

RX - select the output for the audio signal received by the ExpertSDR2, which can be transferred to the third-party software via VAC.

TX - select the input for the audio signal generated by the third-party software and transferred to the ExpertSDR2 via VAC, for transmission on the air.

- **Sample rate** - sampling frequency.
- **Buffer size** - size of the buffer.
- **Channels** - select the amount of the sound card's or virtual audio cable used channels.
- **Latency** - signal delay time.
- **RX gain** - additional signal amplifying in the virtual audio cable's RX path in dB.
- **TX gain** - additional signal amplifying in the virtual audio cable's TX path in dB.

Note:

• *Before enabling the VAC, make sure all settings for audio devices are correct.*

5.3.1.3 VOX

On the **VOX** tab, you can see the settings of the Voice-Operated Transmit system.

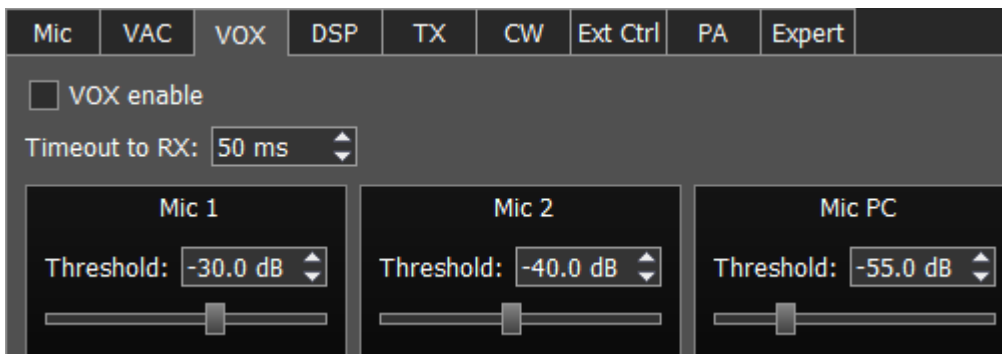

VOX system triggers when the microphones voice signal exceeds the **Threshold**. The **Threshold** could be set for each microphone individually.

Set the **VOX enable** checkbox to enable VOX system.

- **Timeout to RX** - VOX release time.
- **Threshold** - VOX engagement threshold.

5.3.1.4 DSP

On the **DSP** tab you can see the AGC's and Digital Signals Processing settings.

There are two types of settings in the drop-down menu:

AGC - receiver's AGC settings.

DSP - digital processing filter's settings.

Receiver's AGC settings

There you can find fine AGC settings. AGC settings are divided by the processing speed on **Long, Slow, Med, Fast** and **User**.

Each settings type has its own tab and differs from others in terms of Attack, Decay and Hang time.

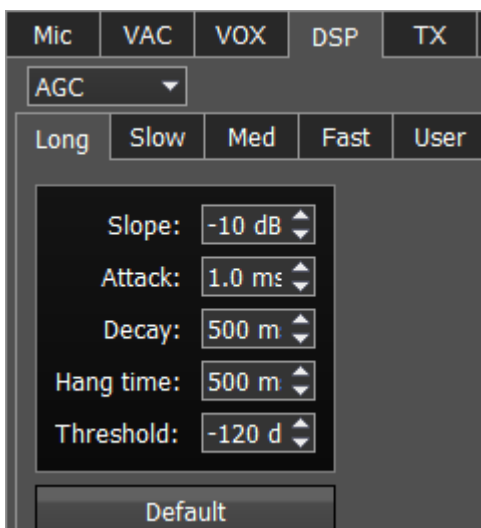

AGC parameters:

Slope - set the slope of the transfer characteristic.

Attack - when a signal gets stronger, this value determines how quickly the AGC will decrease gain.

Decay - when a signal gets weaker, this value determines how quickly the AGC will increase gain.

Hang time - signal recovery time.

Threshold - AGC trigger threshold.

Default - reset AGC setting to the default level. Press the Default button if you set wrong AGC values and don't like the result. Each AGC tab has a Default button.

Digital processing filter's settings.

There you can find fine the settings of the receiver's digital processing filters. DSP functions clear the signal from abnormal noises and crosstalk. These are the standard functions:

The screenshot displays the DSP settings panel in the ExpertSDR2 software. At the top, there are tabs for Mic, VAC, VOX, DSP, TX, CW, Ext Ctrl, PA, and Expert. The DSP tab is selected, and a dropdown menu shows 'DSP'. Below this, there are several control panels for different digital processing functions:

- NR (Noise Reduction):** Taps: 45, Delay: 64, Rate: 0.000010, Leak: 0.000100. Includes a Default button.
- ANF (Auto Notch Filter):** Taps: 60, Delay: 64, Rate: 0.000700, Leak: 0.000010. Includes a Default button.
- CW APF (CW Adaptive Filter):** Gain: 30 dB, Quality: 5. Includes a Default button.
- SSB APF (SSB Adaptive Filter):** Gain: 20 dB, Quality: 1.0, Frequency: 500 Hz. Includes a Default button.
- Filter taps:** SSB: 1537, AM/NFM: 1537, DIGL/DIGU: 1537, CW: 1537. Includes a Default button.
- Noise blanker:** Threshold NB1: 2.65, Threshold NB2: 2.48. Each has a Default button.
- DSE (Digital Signal Enhancement):** Quality: 140, Swap channels (unchecked). Includes a Default button.
- WFM (Wide Frequency Modulation):** USA (unchecked).

NR - Noise Reduction, removes the white noise. This is a special adaptive filter, which removes any abnormal noises from the air in the RX filter band.

ANF - Auto Notch filter, removes the carrier signals. This is a special adaptive filter, which removes any periodical signals from the air in the RX filter band.

- **Taps** - filter taps, determines the quality of the filter functionality.
- **Delay** - trigger delay time.
- **Rate** - set the adaptation rate of the filter.
- **Leak** - set the signal's level.

APF - Analog peak filter for CW and SSB mode. Provides a more comfortable listening of the CW signals by amplifying the CW signal in the center of the receive filter (triangle filter's AFC (amplitude-frequency characteristic) in the filter bandpass).

- **Gain** - Analog peak-filter amplifying factor.
- **Quality** - Analog peak-filter quality (slope sharpness).
- **Frequency** - central frequency of the voice signal.

Filter taps - receiver's filter taps for SSB, AM/NFM, DIGL/DIGU, CW modes, by default 1537.

The higher the receiver's filter taps value, the more rectangular the filter's shape, but it also increases the signal pass delay. That is why the user should find the best settings for himself, between acceptable filter slopes steepness and signal delay. Optimal filter taps are set by default.

Noise blanker - removes impulse interference. Noise blanker parameters:

- **Threshold NB 1, 2** - filter trigger threshold. Set the required filter 1, 2 trigger thresholds, depends on the interference level.

Note:

• *NB has a threshold, set it to cut pulse noise if it surpasses the threshold. As a rule, pulse noise is a high-amplitude and short in time signal, with an amplitude much higher than useful signal. If it will be cut from the mix of signals the useful signal won't be corrupted. For correct operation, the threshold level should be adjusted higher than useful signals. In this case, NB will work perfectly. If the threshold will have the same level as useful signals or lower, the NB will try to cut useful signals and you'll hear and see distorted signals in phones and spectrum scope. If noises have white spectrum (not pulse) with low level (lower than useful signals), the NB cannot be used in this case, use NR.*

DSE - Digital Surround Effect for CW signals. Provides a space orientation in stereo phones, stations from lower frequencies are louder in the left channel, stations from higher frequencies are louder in the right channel. The signal in the filter's center is equally heard in both channels of stereo phones.

- **Quality** - DSE filter quality. The higher the quality value the stronger the function's effect.
- **Swap channels** - swap right and left receiver's channels. Set the Swap channels checkbox for correct DSE functionality, if required. Correct functionality - slowly increasing the receiver tuning frequency, while receiving the CW signal, sounds as if CW signal moves from the right to the left channel.

Note:

◆DSE effect cannot be heard in mono phones.

WFM - Wide FM standard:

- **USA** - set this checkbox to listen to WFM stations in the USA or South Korea.

Default - press to return settings to the default state. Each settings category has the Default button. Press the Default button if you set wrong values and don't like the result.

5.3.1.5 TX

In this tab, you can adjust the TX filter separately for different modes.

PTT switching delays are disabled in CW mode, and with CW manipulation in SSB!

SSB/DIGL/DIGU/AM/DSB - settings for the low or/and high TX filter fronts.

- **Low** - low front filter's frequency.
- **High** - high front filter's frequency.
- **Offset** - frequency offset. Used for work in digital modes. Frequency offset requirement depends on the used digital mode program. Look at the instruction of your digital mode program.
- **Sync with RX** - set this checkbox to make TX filter bandwidth equal to RX filter bandwidth.

Note:

◆Limits of the TX filter bandwidth in SSB mode: low - from 10 Hz up to 10000 Hz, high - from 60 Hz up to 18000 Hz.

Tone - settings for the dual-tone signal.

- **Enable** - enable the dual-tone transmission mode.
- **Frequency 1/2** - set the independent frequency for the Tone 1 and Tone 2 signals respectively.
- **Tone 2** - enable the Tone 2 signal.

NFM - Narrow band receiver FM settings.

- **Deviation** - FM deviation. The width of the FM signal on air will be twice the deviation width.
- **High** - frequency of the high filter slope of the LF signal before FM demodulator. Set the required LF signal width from zero up to high filter edge.

Voice Recorder - settings of the playback level.

- **Volume for TX** - additional gain volume in TX for the voice record. Set this parameter so that the signal on MIC-meter would reach -10...-5 dBW values.

Note:

*♦ If a recorded signal, which was received from the air, wasn't compressed by the transmitter, it has low RMS power - lower, than compressed signal. Voice recorder has its own AGC, it doesn't allow TX signal level to surpass the maximum threshold, to avoid clipping. This AGC has maximum amplitude threshold for audio signal output: +3 dB, it allows an operator to hear slight clipping with a high gain level of voice recorder signal and adjust correct **Volume for TX** coefficient, keeping a good quality of TX signal. The Peak level set in ExpertSDR2 is 0 dB. The RMS signal level is 3 times weaker by amplitude than peak level. TX signal, recorded by the Voice Recorder, is transmitted on the air without processing e.g. TX processing module does not influence signal transmitted via the Voice Recorder.*

PA control - external PA control settings.

- **Enable PA in Tone mode** - checkbox to enable the TX mode of the external PA in the Tone mode (transmission of the carrier frequency). Set the Enable PA in Tone mode checkbox to enable the TX mode for the external PA while transmitting the carrier frequency. This mode might be useful to tune the building out a network of the external PA.

TX Filter Taps - transmit Filter Taps settings.

- **SSB** - Filter Taps in SSB mode.
- **AM/NFM** - Filter Taps in AM mode and narrowband FM.

- **DIGL/DIGU** - Filter Taps in DIGL and DIGU modes.

PTT switching delay - set the delay time between switching the transceiver to RX/TX and the first relay closure.

- **Rx to Tx** - delay time to generate HF signal after turning from RX to TX.
- **Tx to Rx** - when you stop transmitting, the transceiver waits for the certain “delay time” then switches from TX to RX.

Warning!

① **PTT switching delays are disabled in CW mode, and with CW manipulation in SSB!**
Be careful using an external PA!

5.3.1.6 CW

On the **CW** tab, you can see the settings of the additional CW keys.

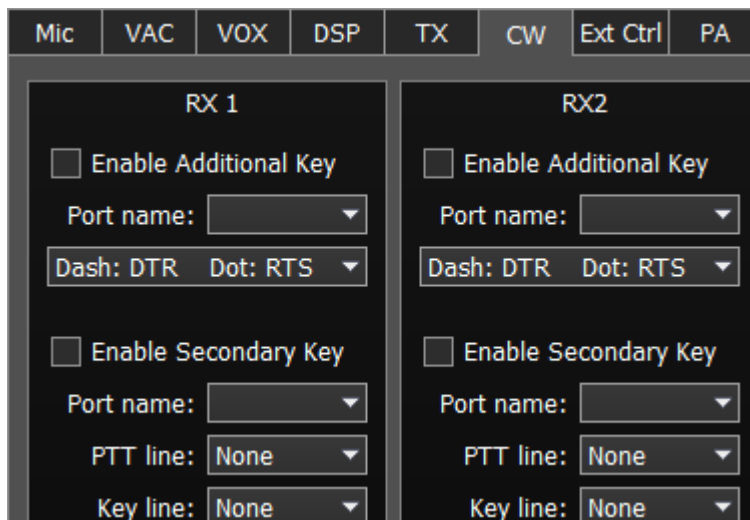

RX1, RX2 - these categories have similar settings for the RX1 and RX2 receivers.

Enable Additional Key - checkbox to enable additional CW key. Set it to enable additional iambic CW key, which is connected to the COM-port.

- **Port name** - COM-port number, which is connected to the key.
- **Lines** - in the Lines drop-down menu you may swap Dot and Dash signals with COM-port bits RTS and DTR.

Enable Secondary Key - checkbox to enable secondary additional CW key. Set it to enable secondary additional CW key, which is connected to the COM-port. As a rule, this port is being used for CW signal generated by the additional software (message logs, contest logs and others).

- **Port name** - COM-port number, which is connected to the key.
- **PTT line** - line menu, is being used to turn the transceiver to the TX mode.
- **Key line** - line menu, is being used to generate CW signal.

5.3.1.7 Ext Ctrl

To control external devices, the transceiver has a special connector **Ext Ctrl**. Settings could be adjusted separately for the RX mode and TX mode.

The **Ext Ctrl** connector output consists of the keys with open collector. For more details on how to use the Ext Ctrl connector, look up the "[Connecting an external PA, fan, relay etc. to the SunSD2 PRO](#)" document.

The best way to use this feature is to switch the narrow-band filters in the RX mode and switch the LPF in the TX mode. Also, you may arrange your own antenna switch, having only the relay.

Mic	VAC	VOX	DSP	TX	CW	Ext Ctrl	Expert
<input checked="" type="checkbox"/> Enable	<input type="checkbox"/> Thermostat	t High °C: 35		t Low °C: 30			
RX Mode:				TX Mode:			
	1	2	3	4	5	6	7
160M:	<input type="checkbox"/>	<input type="checkbox"/>	<input type="checkbox"/>	<input type="checkbox"/>	<input type="checkbox"/>	<input type="checkbox"/>	<input type="checkbox"/>
80M:	<input type="checkbox"/>	<input type="checkbox"/>	<input type="checkbox"/>	<input type="checkbox"/>	<input type="checkbox"/>	<input checked="" type="checkbox"/>	<input type="checkbox"/>
60M:	<input type="checkbox"/>	<input type="checkbox"/>	<input type="checkbox"/>	<input type="checkbox"/>	<input type="checkbox"/>	<input checked="" type="checkbox"/>	<input type="checkbox"/>
40M:	<input type="checkbox"/>	<input type="checkbox"/>	<input type="checkbox"/>	<input type="checkbox"/>	<input type="checkbox"/>	<input checked="" type="checkbox"/>	<input type="checkbox"/>
30M:	<input type="checkbox"/>	<input type="checkbox"/>	<input type="checkbox"/>	<input type="checkbox"/>	<input type="checkbox"/>	<input checked="" type="checkbox"/>	<input type="checkbox"/>
20M:	<input type="checkbox"/>	<input type="checkbox"/>	<input type="checkbox"/>	<input type="checkbox"/>	<input type="checkbox"/>	<input checked="" type="checkbox"/>	<input type="checkbox"/>
17M:	<input type="checkbox"/>	<input type="checkbox"/>	<input type="checkbox"/>	<input type="checkbox"/>	<input type="checkbox"/>	<input checked="" type="checkbox"/>	<input type="checkbox"/>
15M:	<input type="checkbox"/>	<input type="checkbox"/>	<input type="checkbox"/>	<input type="checkbox"/>	<input type="checkbox"/>	<input checked="" type="checkbox"/>	<input type="checkbox"/>
12M:	<input type="checkbox"/>	<input type="checkbox"/>	<input type="checkbox"/>	<input type="checkbox"/>	<input type="checkbox"/>	<input checked="" type="checkbox"/>	<input type="checkbox"/>
10M:	<input type="checkbox"/>	<input type="checkbox"/>	<input type="checkbox"/>	<input type="checkbox"/>	<input type="checkbox"/>	<input checked="" type="checkbox"/>	<input type="checkbox"/>
6M:	<input type="checkbox"/>	<input type="checkbox"/>	<input type="checkbox"/>	<input type="checkbox"/>	<input type="checkbox"/>	<input type="checkbox"/>	<input checked="" type="checkbox"/>
2M:	<input type="checkbox"/>	<input type="checkbox"/>	<input type="checkbox"/>	<input type="checkbox"/>	<input type="checkbox"/>	<input type="checkbox"/>	<input checked="" type="checkbox"/>
GEN:	<input type="checkbox"/>	<input type="checkbox"/>	<input type="checkbox"/>	<input type="checkbox"/>	<input type="checkbox"/>	<input type="checkbox"/>	<input type="checkbox"/>

You may use the 7th key to control a cooling fan for the transceiver heatsink. There is a **Thermostat** feature implemented in the software, via this feature you may control the fan and set operational temperature thresholds.

Enable - checkbox to enable control of the electronic keys.

Thermostat - activate the Thermostat mode and the seventh key. It doesn't matter what checkboxes were set in the 7-th column before, but it would be better if none, just in case.

Note:

•The pin 14 directly connected to an external power supply connector and has the same voltage. Also, pin 14 power line has a 1A fuse and serial diode for protection. The GND 15 pin has a direct connection to common GND of the radio and direct connection to negative pin of the power supply connector. You should set protective diode in parallel with FAN, cathode to +V, anode to -V.

t High C - high-temperature limit to turn on the fan.

t **Low C** - low-temperature limit to turn off the fan.

RX Mode - electronic keys settings in the RX mode.

TX Mode - electronic keys settings in the TX mode.

1...7 - electronic keys numbers.

160...2, GEN - electronic key enable checkbox on the corresponding band.

Note:

• *On the picture above, you can see the example of using the keys in the 160M, 80M and 60M bands for both RX and TX modes.*

While working on the 160M band in the RX mode, #1 key is enabled, if turn to TX mode, #1 key is still active.

While turning on 80M band, #2 key will be enabled (#1 key will be disabled), it is active in both RX and TX modes.

While turning on 60M band, #3 key will be enabled (#2 key will be disabled), it is active in both RX and TX modes.

• *Connecting relays to these keys, you may create an additional antenna switch, band filters switch, PA band switch etc.*

5.3.1.8 Expert

On the **Expert** tab you can see the fine hardware settings of the transceiver.

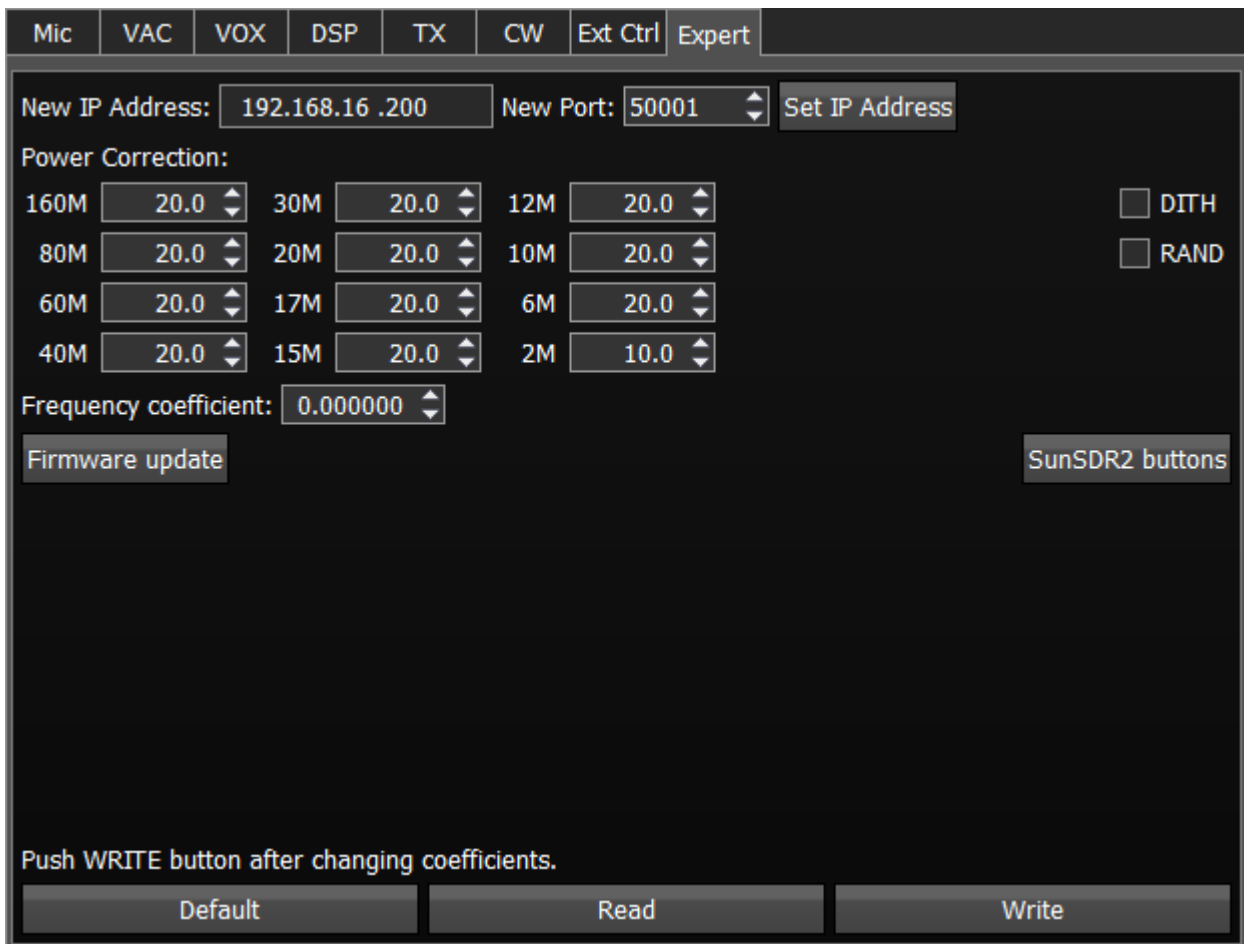
Note:

- All settings in this tab are stored in the transceiver's energy independent memory.
- After setting the required values, set/unset checkboxes, press the **Write** button to save the settings.
- To read the current settings state from the memory, press the **Read** button. Auto-read happens with every software launch.

New IP Address - an input box to enter new IP Address.

New Port - an input box to enter the New Port.

Set IP Address - a button to activate the new values of the IP address and Port.

Power Correction - output power correction menu, set the output power value for each band. Value = 20 means the maximum output power of the transceiver.

Note:

- Adjustments may be required when connecting an external power amplifier to the transceiver.
- After tuning the power values, press the **Write** button.

Frequency coefficient - Correction menu of the transceiver's frequency tuning.

Set the coefficient that the transceiver's tuning frequency would be equal to the real frequency of the received signal.

Note:

- Correction of the displayed frequency could be made according to the time signals on the 4.996MHz, 9.996MHz or 14.996MHz (preferably) frequencies, where you can find easily tracked pulse signals. If they do not match with the tuned frequency, adjust the **Frequency coefficient** till the frequency match.

- The higher the frequency of the used time signal, the higher calibration accuracy.

- Calibration should be performed with the maximum panorama zoom and maximum FFT size of the panorama (more detail about FFT size in [Spectrum](#) ).

- After you set the frequency correction coefficient, press the **Write** button.

- The devices are calibrated at the manufacturing by default, additional calibration is not required.

Firmware Update - Button for manual firmware update in the transceiver.

Press the **Firmware update** button to initialize firmware update process.

DITH - Checkbox to enable the internal noise source in the ADC.

Set the **DITH** checkbox to enable internal noise source of the receiver's high-speed ADC.

Note:

- After set/unset of the **DITH** checkbox, press the **Write** button .

- Internal noise source in the ADC gives an additional linearity to the receiver's ADC functionality. As a rule used for lab measurements for receiver's linearity with other devices.

- While operating in real air, noise source is an actual noise of the air, that's why there is no need to enable **DITH** function.

- If **DITH** is enabled, receiver's own noise is increased.

RAND - Checkbox to enable bits randomizing on the ADC's data bus.

Set the **RAND** checkbox to enable bits randomizing on the receiver's ADC data bus.

Note:

- After set/unset of the **RAND** checkbox, press the **Write** button.

- Bits randomizing on the ADC's data bus leads to lessening the noise from this bus to the receiver.

- It is recommended to keep this checkbox on all the time.

SunSDR2 buttons - press this button to open the window with inputs state indicators (for developers), checkboxes are set when the certain input is activated:

- SunSDR2 PTT - PTT footswitch indicator;
- MH31 PTT - PTT microphone indicator;
- SunSDR2 DASH/DOT - CW key indicators;
- Input 1/2 - ExtCTRL indicators.

Default - Default hardware settings button.

Press the **Default** button to return to the default settings.

Read - Read the hardware settings from the transceiver's memory.

Press the **Read** button to read the hardware settings from the transceiver's memory.

Write - Store the hardware settings.

Press the **Write** button to store the hardware settings in the transceiver's memory.

5.3.2 Sound card menu

In the **Sound card** menu you can see the settings of the audio devices, which can be used with the transceiver.

The audio signal output is carried out via the **PHONES** connector on the front panel of the transceiver. If you'll connect to the transceiver remotely, you may use PC's sound card for the audio signal output, which will be simultaneous with audio output from the transceiver.

5.3.2.1 Sound card

In the **Sound card** category, you can see the settings of the sound card, which can be used for sound output in the RX mode.

Note:

- Signal output delay via the sound card can reach 250-500 ms. It can be adjusted with buffer size (smaller values equal lower delay) or selecting different Audio driver (MME - the biggest latency / WDMKS - moderate latency / ASIO - minimal latency).

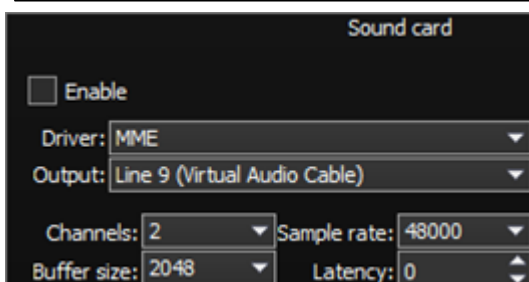

- **Enable** - Checkbox to enable PC's sound card.
Set the **Enable** checkbox to enable sound output via the sound card.
- **Driver** - Select the sound card's driver type.
- **Output** - Select the sound card's physical output.
- **Channels** - Select the amount of active sound card's channels.
- **Sample rate** - Sampling frequency.
- **Buffer size** - Buffer size.
- **Latency** - signal delay time.

Note:

• Before you'll enable the **Sound card** by the **Enable** checkbox, make sure that all sound devices settings are set correctly.

5.3.2.2 Line output

In the **Line output** category you can see the settings of the sound card or virtual audio cables, which could be used for linear sound output in the RX and TX modes, separately for RX1 and RX2 receivers.

Note:

• Sound output via the **Line output** will be simultaneous with the sound output from the transceiver.

• **Line output** volume has a constant max value and cannot be changed by the operator.

• As a rule sound output via the **Line output** is used for recording communications in contests and other purposes.

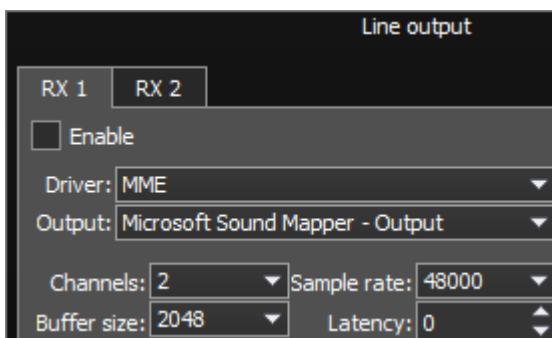

There are two tabs with identical settings for RX1 and RX2 receivers, in the **Line output** category, let's look at one of them.

- **Enable** - Checkbox to enable **Line output**.
Set the **Enable** checkbox to enable **Line output**.
- **Driver** - Choose the sound device' driver type.
- **Output** - Choose the sound device' physical output.

- **Channels** - Choose the amount of active sound device' channels.
- **Sample rate** - Sampling frequency.
- **Buffer size** - Buffer size.
- **Latency** - signal delay time.

Note:

• Before you'll enable the **Line output** by the **Enable** checkbox, make sure that all sound devices settings are set correctly

5.3.3 Display menu

In the **Display** menu you can see the settings of the transceiver's software display. Display settings are placed according to their functionality:

- "Main window" tab
- "Spectrum" tab
- "Waterfall" tab
- "Grid" tab
- "Filter" tab
- "Background" tab
- "Indicators" tab

5.3.3.1 Main window

On the **Main window** tab, you can see the settings of the transceiver's software main window display.

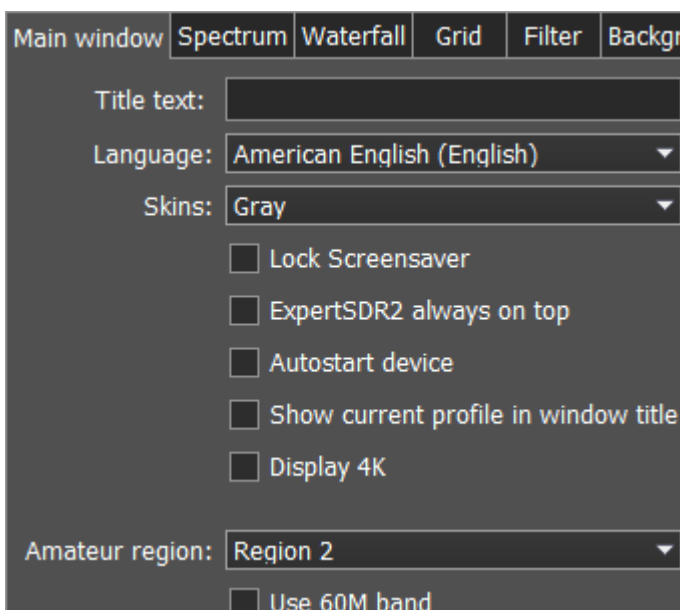

- **Title text** - Input box to enter the title.
Enter your call-sign or other information in the **Title text** box, it will always be displayed in the software title.
- **Language** - Interface language menu.
Select the required language from the list.
- **Skins** - Software color theme menu.
Select the required software color theme from the list.
- **Lock Screensaver** - Lock screen-saver checkbox.
Set the **Lock Screensaver** checkbox to block the display turn off by the Windows OS.
Recommended checkbox setting - on.
- **ExpertSDR2 stays on top** - On top checkbox.
Set the **ExpertSDR2 stays on top** checkbox to see ExpertSDR2 window constantly on top of other windows.
Recommended checkbox setting - off.
- **Autostart device** - Receiver's autostart checkbox.
Set the **Autostart device** checkbox to automatically start the receiver after the launch of the software.
Recommended checkbox setting - on.
- **Show current profile in window title** - Display the current profile in the software window title.
Set the **Show current profile in window title** checkbox to display the current profile (if the profile is on) in the software window title.
- **Display 4K** - display mode for 4K monitors.
- **Amateur region** - Amateur region menu.
Select the region you are currently in, in the Amateur region menu.

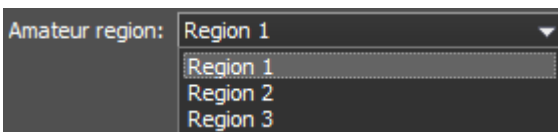

It affects the position of the amateur bands in the software.

- **Use 60M band** - set the **Use 60M band** checkbox to enable 60M band.

Note:

• After you select the amateur region and/or set/unset the checkbox Use 60M band you'll see the notification window, that the settings will be applied after the restart of the software. Restart the software.

5.3.3.2 Spectrum

On the **Spectrum** tab you can see the transceiver's spectrum settings.

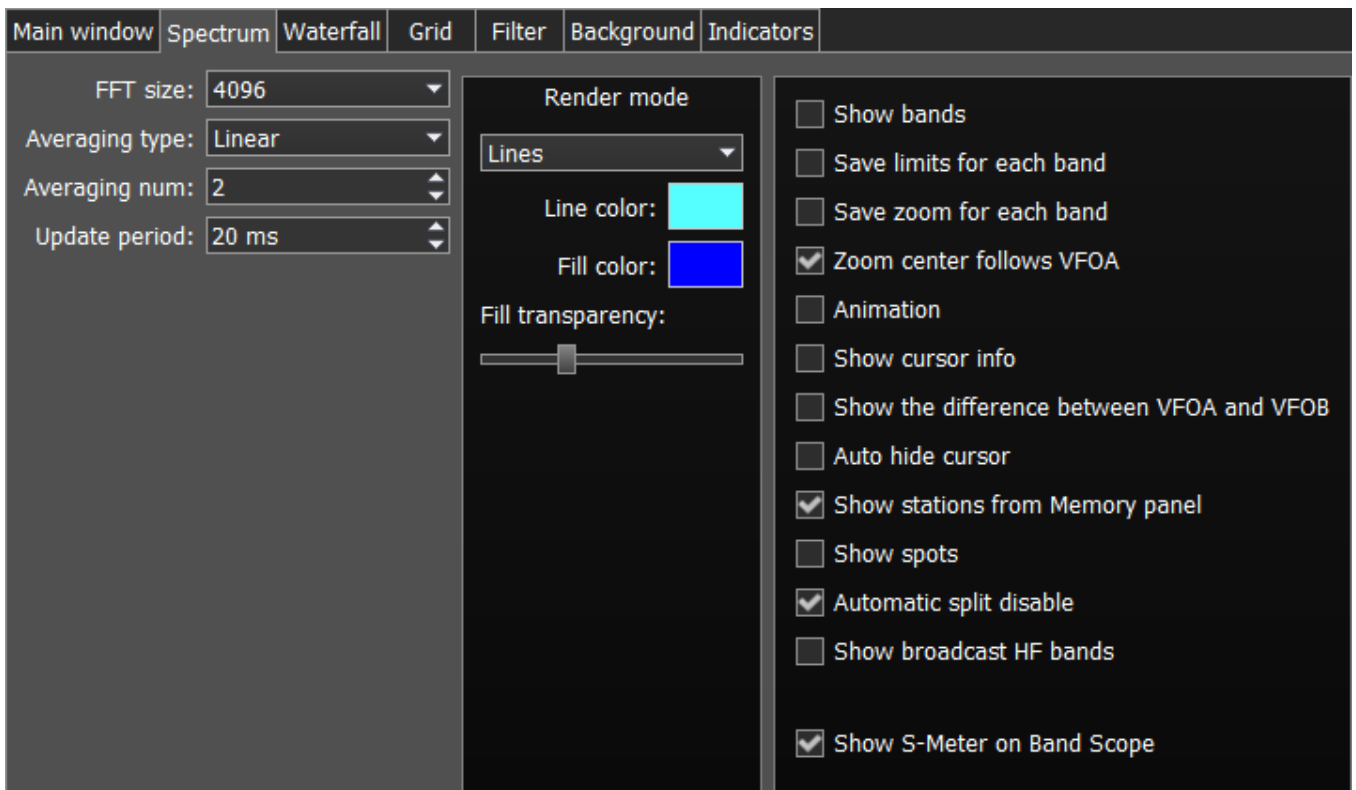

- **FFT size** - Fast Fourier Transform (FFT) size of the spectrum scope.
Select the required FFT size. The higher FFT size, the higher spectrum scope resolution by frequency, along with the higher processor load.
- **Averaging type** - Spectrum scope averaging type menu.
Select the averaging type from the list: Linear, root-mean-square (Rms), Exponential, which suits you best.
- **Averaging num** - A number of samples for averaging.
Set the required amount of samples for averaging. The bigger a number of samples, the slower the spectrum will change on the graph.
- **Update period** - Spectrum scope update period.
Set the required specter's graph update period. The bigger the number, the more FPS on the spectrum scope, along with the higher processor load.

Render mode - Spectrum render mode: lines, gradient.

Set the required specter render mode.

- **Line color** - Spectrum scope line color.
Select the required line color from the palette.
- **Fill color** - Fill color of the spectrum scope lower area.
Select the required fill color from the palette.
- **Fill transparency** - Transparency slider for the spectrum scope lower area filling.
Set the required filling transparency level.

- **Show bands** - Show amateur bands borders.
Set the **Show bands** checkbox to show amateur bands borders at the top of the spectrum scope (blue line).
- **Save limits for each band** - Save spectrum scope amplitude limits for each band.
Set the **Save limits for each band** checkbox to enable the software to save set spectrum scope limits for each band.
- **Save zoom for each band** - Save spectrum scope zoom settings for each band.
Set the **Save zoom for each band** checkbox to enable the software to save spectrum scope zoom settings for each band.
- **Zoom center follows VFOA** - Zoom center marker locked on the VFOA position on the spectrum scope.
Set the **Zoom center follows VFOA** checkbox to enable the zoom center marker lock on the VFOA position.
- **Animation** - Spectrum scope animation while transitioning between bands.
Set the **Animation** checkbox to enable animation.
- **Show cursor info** - Show frequency and dB level of the cursor position.
Set the **Show cursor info** checkbox to enable info display near the cursor on the spectrum scope.
- **Show the difference between VFOA and VFOB** - Show the difference between VFOA and VFOB.
Set the **Show the difference between VFOA and VFOB** checkbox to display the difference between VFOA and VFOB near the cursor.
- **Auto hide cursor** - Automatically hide the cursor from the spectrum scope.
Set the **Auto hide cursor** checkbox to let the cursor disappear after idle 2 seconds.
- **Show stations from Memory panel** - Show the stations previously stored in the frequency memory.
Set the **Show stations from Memory panel** checkbox to show on the spectrum scope previously stored stations as markers (blue dots in the top area of the spectrum scope). When rollover the station's marker you'll see the commentary.
- **Show spots** - Show spots from the CW Skimmer on the spectrum scope.
Set the **Show spots** checkbox to show spots from the CW Skimmer on the spectrum scope as a markers with call-signs.
- **Automatic SPLIT disable** - SPLIT function is automatically disabled when you change the mode type or frequency band, VFO B frequency becomes equal to VFO A frequency.
- **Show broadcast HF bands** - enable for display of broadcast HF bands on panorama and Band Scope.
- **Show S-Meter on Band Scope** - Show the S-Meter on the Band Scope.
Set the **Show S-Meter on Band Scope** checkbox to show the S-Meter on the Band Scope for each VFO.

5.3.3.3 Waterfall

On the **Waterfall** tab you can see the transceiver's waterfall settings.

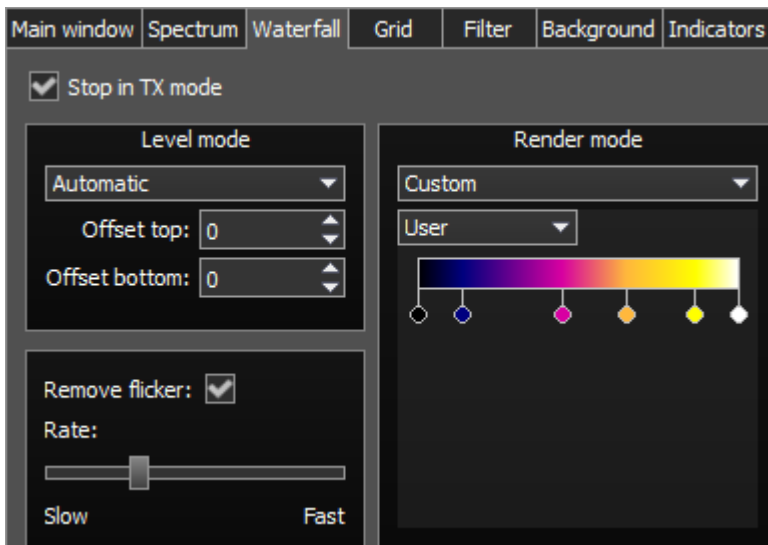

- **Stop in TX mode** - Stop the waterfall in TX mode.
Set the **Stop in TX mode** checkbox to disable the waterfall while transmitting.
- **Level mode** - Waterfall bright menu.
Select the bright mode from the list: Automatic, Synchronous.
Automatic mode depends on air signals and set offset in the settings below.
Synchronous mode depends on the set limits of the spectrum amplitude.
- **Offset top** - Offset input box by the top dB level relatively to signals level.
Set the offset in the **Offset top** box to determine the maximum brightness relatively to the max signals' levels.
- **Offset bottom** - Offset input box by the bottom dB level relatively to signals level.
Set the offset in the **Offset bottom** box to determine the minimum brightness relatively to the min signals' levels.
- **Render mode** - waterfall render mode menu: Rainbow, Monochrome, Custom. Select the required color render of the waterfall, depending on your choice or tasks. In the Custom mode, you have three colors presets: 1,2,3 and User adjustable mode.
In the User preset there are 6 color markers at maximum. Double click of the left mouse button on the color marker opens the color menu, double click of the right mouse button on the color marker delete it. Double click of the left mouse button on the empty space adds the color marker.
- **Remove flicker** - Checkbox to remove the waterfall flickers.
Set the **Remove flicker** checkbox to get rid of the texture flickers in the waterfall, also it slightly clears the waterfall from air noises.
- **Rate** - Waterfall movement speed slider.
Set the **Rate** slider according to the required waterfall movement speed.

5.3.3.4 Grid

On the **Grid** tab you can see the spectrum scope grid display settings.

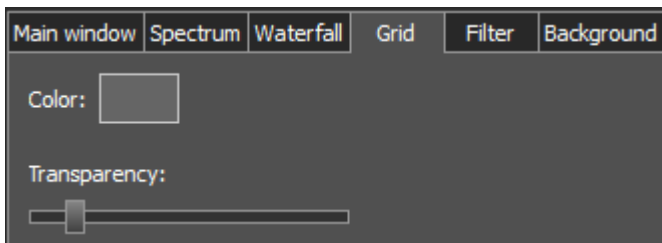

- **Color** - Color of the spectrum scope grid.
Select the required grid color from the palette.
- **Transparency** - Grid transparency slider.
Set the required grid transparency by moving the slider.

5.3.3.5 Filter

On the **Filter** tab you can set the required color of filters and the necessity to display the additional text information.

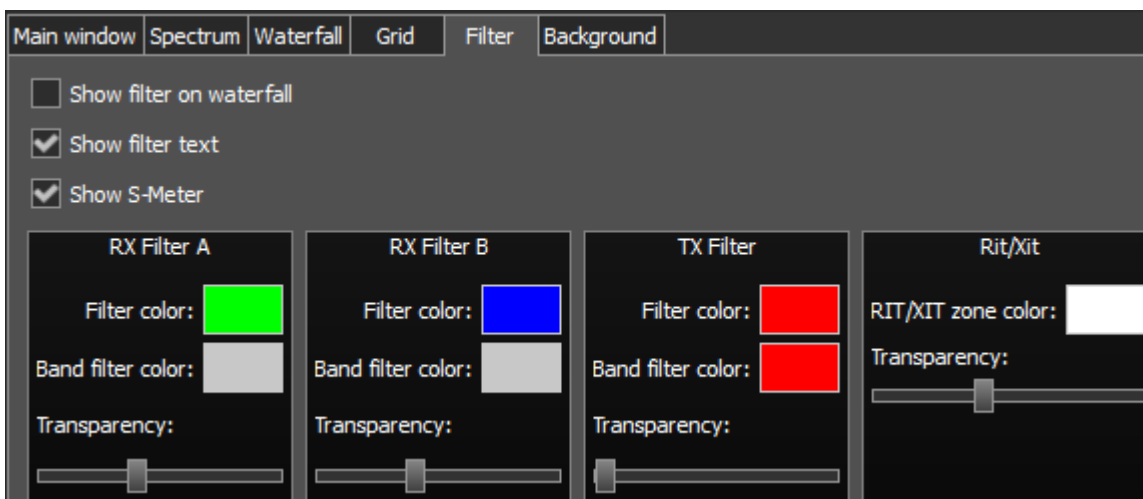

- **Show filter on waterfall** - Show receiver(s) filter on the waterfall.
Set the **Show filter on waterfall** checkbox to show receiver(s) filter on the waterfall.
- **Show filter text** - Show text info near the receiver's filter on the spectrum.
Set the **Show filter text** checkbox to display filter's tuned frequency, signal level in S-units etc. in the used filter bandwidth.
- **Show S-Meter** - Enable animated S-Meter near the receivers' filter on the spectrum.
Set the **Show S-Meter checkbox** to display S-Meter near the receiver's filter.

In the **RX Filter A**, **RX Filter B**, **TX Filter** categories displayed filters' color and transparency settings.

- **Filter color** - Filter's frequency color menu.
Choose the required filter's tuned frequency color from the palette.
- **Band filter color** - Filter's bandwidth color menu.
Choose the required filter's bandwidth color from the palette.
- **Transparency** - Filter's transparency slider.
Set the required filter's transparency.

In the **Rit/Xit** category displayed RIX/XIT active zone settings.

- **Rit/Xit zone color** - RIX/XIT active zone color menu.
Choose the required RIX/XIT active zone color from the palette.
- **Transparency** - RIX/XIT zone transparency slider.
Set the required RIX/XIT zone transparency.

5.3.3.6 Background

On the **Background** tab you can see the spectrum scope background settings.

Background type - Spectrum scope background type menu: **Solid**, **Gradient**, **Image**.
Select in the **Background type** menu spectrum scope background render type.

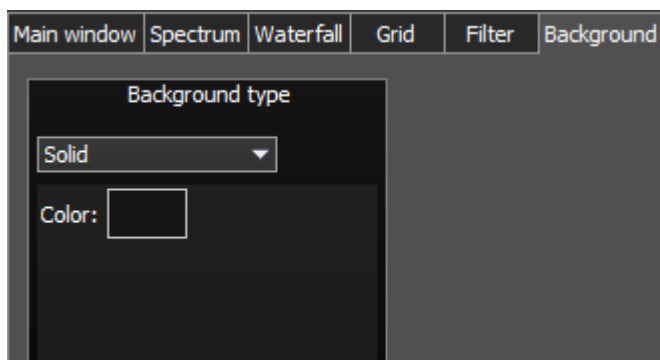

In the **Solid** mode available settings are:

- **Color** - Background color menu.
Choose the required background color from the palette.

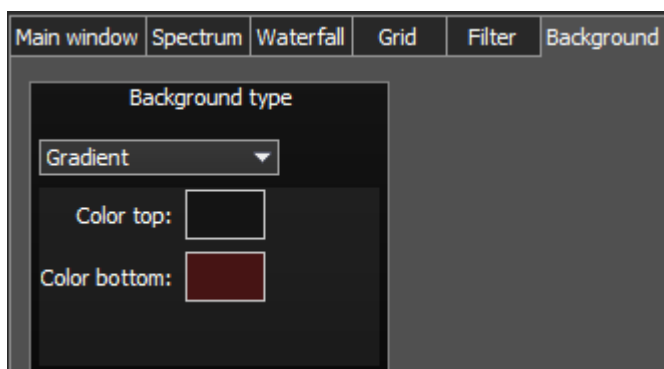

In the **Gradient** menu available settings are:

- **Color top** - Top gradient color of the background.
Choose the required top gradient color from the palette.
- **Color bottom** - Bottom gradient color of the background.
Choose the required bottom gradient color from the palette.

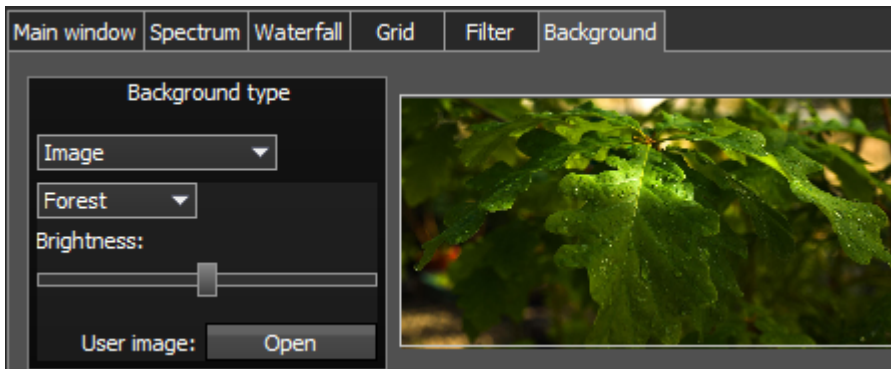

In the **Image** menu available settings are:

- **Image menu** - Image presets menu (Forrest, Bubbles, Space, Water, User).
Pick the required image from the menu or lock one of your own images.
- **Brightness** - Background image brightness slider.
Set the required background image brightness.
- **User image** - Choose the required image to be displayed on the background.
Press the **Open** button, in the opened window choose the image file to set as the background.

Note:

• If the image file wasn't chosen previously via the **Open** button, then if you choose the User image in the presets list it'll open the window to choose the image file.

• Supported files types: png, jpg, jpeg, bmp.

5.3.3.7 Indicators

In the **Indicators** tab you can change the algorithm of the output power readings on the transmitter output.

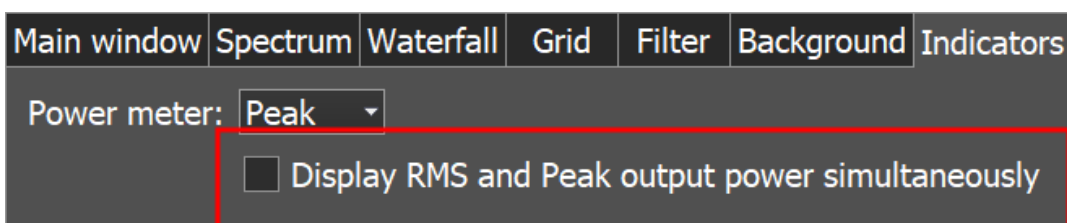

In the Peak/RMS drop-down menu you set the type of output power which is displayed on the Power and S-meters. What you check there always displayed as text on the Power meter.

Display RMS and Peak output power simultaneously - check to see both **Peak** and **RMS** indicators on Power meter and S-meter. If checked, the **Peak** power displayed as **orange** indicator on the Power meter and **red** needle on the S-meter.



5.3.4 CAT menu

In the **CAT** menu, you can see the CAT-system settings. CAT-system is the transceiver's exchange interface with external devices and software.

CAT-interface is used for control of the transceiver from a third-party software. This could be contest logs, digital modes decoder-software, SAT-tracker etc. RX1 and RX2 have independent settings and could be controlled separately via the CAT-protocol.

5.3.4.1 ECATv1

ECATv1 - exchange protocol compatible with TS-480 transceiver. This protocol allows exchanging data with external devices and software via COM-port.

Protocol: ECATv1

RX 1 RX 2

Enable CAT Enable PTT View log

Port name: Port name:

Parity: None DTR

Data: 8 RTS

Stop bit: 1 Enable Footswitch

Baud rate: 9600 Port name:

PTT line: None DTR

Key line: None RTS

Enable SubRX control (FR command)

Antenna switch control

Global volume control

- **Enable CAT** - Checkbox to enable control of the transceiver via the CAT-system.
- **Port name** - COM-port number.
- **Parity** - Parity.
- **Data** - Amount of data in bits.
- **Stop bit** - Amount of stop bits.
- **Baud rate** - Port speed.
- **PTT line** - COM-port line to activate the TX mode.
- **Key line** - COM-port line for the CW mode.
- **DTR/RTS** - COM-port line for the PTT mode.
- **Enable SubRX control (FR command)** - Checkbox to enable control of the sub-receiver via the CAT-system.
Set the **Enable SubRX control (FR command)** checkbox to enable the control of the sub-receiver via the CAT-system.
- **Antenna switch control** - Checkbox to enable control of the antenna switch via the CAT-system.
Set the **Antenna switch control** checkbox to enable the control of the antenna switch via the CAT-system. Useful for the Ham Radio Deluxe software.
- **Global volume control** - When this checkbox is enabled, you control the global volume with the Volume slider, on the top of the software window, from the CAT-system. Recommended when you use one RX or VFO A only, SubRX is disabled.
- **Enable PTT** - Checkbox to enable control of the TX mode via the COM-port.
Set the **Enable PTT** checkbox to enable the control of the TX mode via the COM-port.

- **Port name** - COM-port number.
- **DTR/RTS** - COM-port line for receiving the PTT commands.
Set one of the **DTR/RTS** line checkboxes to select them as a control.
- **Enable Footswitch** - Checkbox to enable control of rerouting the PTT signal from footswitch to additional COM-port.
Set the **Enable Footswitch** checkbox to enable rerouting of the PTT signal from footswitch to additional COM-port.
- **Port name** - COM-port number.
- **DTR/RTS** - COM-port line for receiving the PTT commands.
Set one of the **DTR/RTS line** checkbox to select them as a control.
- **View log** - display CAT command log.

5.3.4.2 OmniRig

There is an experimental function to synchronize any of our devices with an external device via the [OmniRig](#) software.

OmniRig - exchange protocol via the OmniRig software.

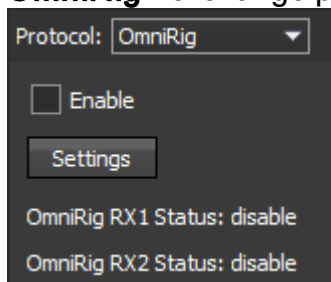

Note:

Using the OmniRig software you can send a limited set of control commands.

Available control commands:

Set VFO frequency, if no VFOB in the CAT protocol;

Set VFO A frequency;

Set VFO B frequency;

Enable receiver's RIT offset;

Set RIT offset; - Reset RIT offset;

Enable transceiver's XIT offset;

Set mode type;

Enable SPLIT.

In the **OmniRig** menu you can find the settings of the OmniRig software.

Enable - set the **Enable** checkbox to control the receiver via the OmniRig software.

Settings - press the **Settings** button to open the OmniRig software settings.

Note:

✦ If the ExpertSDR2 software uses OmniRig protocol to exchange data with an external contest log software, which also uses OmniRig, then COM-port and other settings in the OmniRig software are not required. Select in the OmniRig settings any idle COM-port in the system, to avoid conflict.

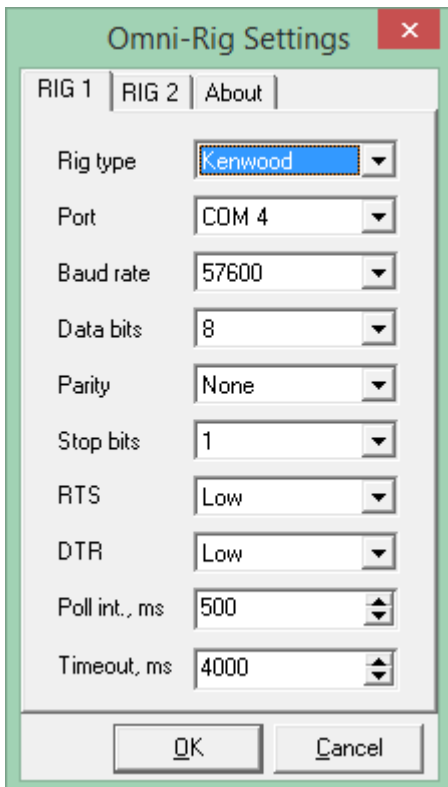

OmniRig RX1 Status - RX1 receiver and OmniRig connection status.

OmniRig RX2 Status - RX2 receiver and OmniRig connection status.

5.3.5 Panel menu

In the **Panel** menu you can see the settings of the E-Coder control panel.

In the drop-down Device menu, you can select the type of the connected control panel. In the meantime only one type is available - E-Coder.

Note:

*✦ If one E-Coder panel is connected to the transceiver in the **Panel** menu displayed one **E-Coder 1** tab, if a several E-Coder panels are connected to the transceiver in the **Panel** menu displayed a several tabs **E-Coder 1**, **E-Coder 2** etc. with identical settings for each panel.*

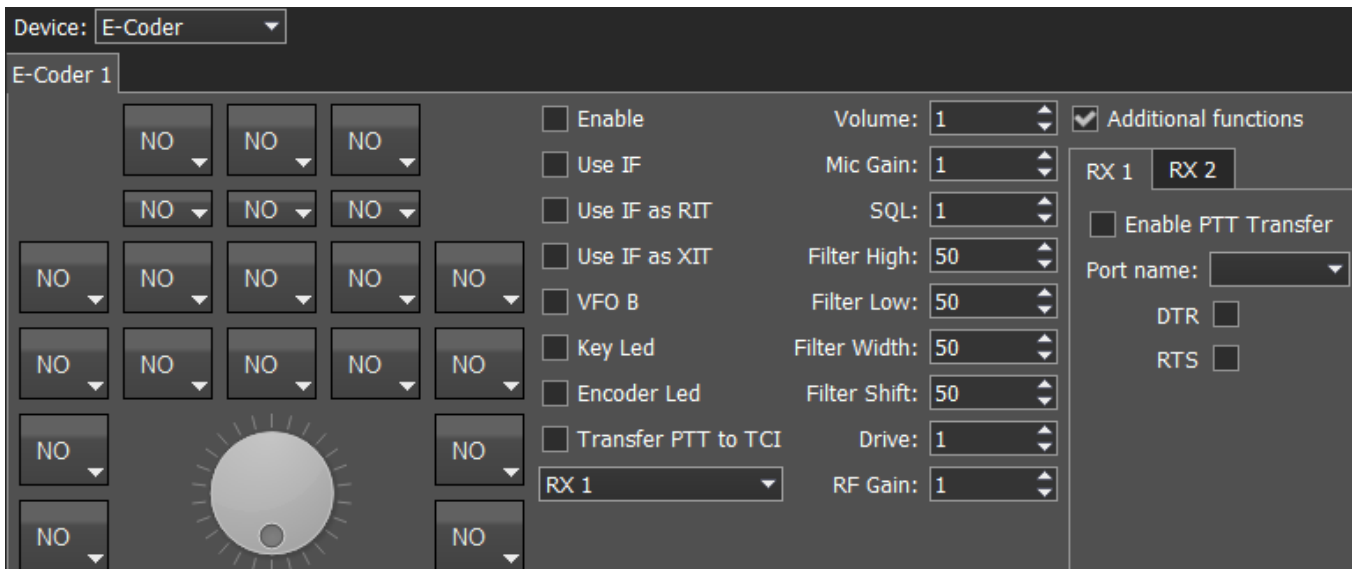

In the left part of the menu you can see the schematic picture of the E-Coder panel with buttons and knobs. Press any button, you'll see the list of the available functions.

Note:

- The list of the available functions is constantly growing. Keep track of the software updates.
 - You can make a request to add a new function on the control button.
-

The following functions may be assigned to the E-Coder panel buttons:

Unused - button is unused.

Main:

AGC Up/Down - AGC type switching.

Band Up/Down - band switching.

Filter Up/Down - receiver's filter switching.

Mode Up/Down - mode switching.

MOX - enable/disable manually operated transmit mode.

PA - enable/disable power amplifier.

Preamp Up/Down - preamp or attenuator level switching.

Start/Stop - start/stop the ExpertSDR2.

RX ANT - enable/disable receive antenna.

Step Up/Down - change the tuning step.

Tone - enable/disable tone signal in TX mode.

WF - enable/disable **Wide Filter**. Filter for all Nyquist zone. If in the **Device** menu settings, you set **Auto enable** checkbox, then you don't need this function on the panel.

Zoom In/Out - spectrum zoom modes switching.

VFO/RX2:

A>B - assign the frequency from heterodyne VFO A to heterodyne VFO B.

B>A - assign the frequency from heterodyne VFO B to heterodyne VFO A.

B<>A - frequency exchange between VFO A and VFO B.

Change VFO A/VFO B - switching between VFO A and VFO B.

IF as RIT - tune the RIT offset by moving the filter over the panorama.

LOCK - lock the frequency tuning.

RX2 On/Off - enable/disable RX2.

RIT On/Off - enable/disable RIT offset.

RIT Reset - reset RIT offset to 0.

Sub RX On/Off - enable/disable SubRX.

Split - enable/disable Split mode.

Switch DDS/IF - tuning the frequency by moving the filter over the panorama, in other words changing the digital IF, or when filter stands still and spectrum moves, this is the central frequency tuning.

Switch Receiver - switching between software RX1 and RX2. The main knob will tune the frequency of one of the receivers.

XIT On/Off - enable/disable XIT offset.

XIT Reset - reset XIT offset to 0.

While you operate both RX1 and RX2, usually you need to listen to either only one of them or both of them, but in different channels (left / right). To do that we added special functions to the E-Coder panel, which set the mixer for both RXs.

Audio:

Listen both RX1, RX2 - default settings, both RXs have equal volume in both channels.

Listen RX1 only - listen to the RX1 in both channels.

Listen RX2 only - listen to the RX2 in both channels.

Listen RX1 in left channel, RX2 in right - listen to the RX1 in the left channel and RX2 in the right channel.

Listen RX1 in right channel, RX2 in left - listen to the RX1 in the right channel and RX2 in the left channel.

Similar settings were added for VFOs:

Listen both VFO A/B - default settings, both VFOs have equal volume in both channels.

Listen VFO A only - listen to the VFO A in both channels.

Listen VFO B only - listen to the VFO B in both channels.

Listen VFO A in left channel, VFO B in right - listen to the VFO A in the left channel and VFO B in the right channel.

Listen VFO A in right channel, VFO B in left - listen to the VFO A in the right channel and VFO B in the left channel.

Mute - switch off the sound.

Switch RX and mute former - change the software receiver and mute former one.

TX/Play - turn to TX and play the signal record in air.

Voice recording - enable/disable voice recording.

Volume Up/Down - volume adjustment.

DSP:

ANF - enable/disable auto notch filter.

APF - enable/disable analog pick filter.

BIN - enable/disable binaural mode.

NR - enable/disable noise reduction.

NB1 - enable/disable noise blanker 1.

NB2 - enable/disable noise blanker 2.

SQL - enable/disable squelch.

The following functions may be assigned on the E-Coder panel knobs:

Unused - encoder is unused.

Volume - volume adjustment.

Mic Gain - Mic gain adjustment.

SQL - squelch threshold adjustment.

Filter Low/High - tuning the frequency of the low/high filter's front.

Filter Width - adjusting the filter width.

Filter Shift - shifting the filter's central frequency.

Drive - adjusting the output power.

IF - tuning the frequency by moving the filter over the panorama.

RF Gain - RF Gain control.

CW Speed - CW Speed control.

RIT Offset - adjusting the RIT Offset.

XIT Offset - adjusting the XIT Offset.

In the right part of the menu you can see the main panel settings:

Enable - enable E-Coder panel control.

Use IF - frequency tuning by moving the filter over the panorama.

Use IF as RIT - tuning by IF when the RIT offset is on.

Use IF as XIT - tuning by IF when the XIT offset is on.

VFO B - enable sub-receiver.

Key Led - enable backlit keypad.

Encoder Led - enable backlit encoder.

Transfer PTT to TCI - enable reroute of the PTT signal from the panel to TCI, has higher priority than **COM-port PTT transfer** (described below).

RX1/RX2 menu - switching between RX1 and RX2 receivers, or assign an exact E-Coder panel to your receiver.

Volume - set the volume change step, per knob's clack.

Mic Gain - set the Mic gain change step, per knob's clack.

SQL - set the squelch threshold change step, per knob's clack.

Filter High - set the filter's high limit change step, per knob's clack.

Filter Low - set the filter's low limit change step, per knob's clack.

Filter Width - set the filter's width change step, per knob's clack.

Filter Shift - set the filter's shift change step, per knob's clack.

Drive - set the output level power change step, per knob's clack.

RF Gain - set the RF gain step, per knob's clack.

Additional functions:

RX1/RX2 tab - COM-port settings tab for rerouting the PTT signal from the panel to the COM-port.

Enable PTT Transfer - rerouting of the PTT signal from the panel to the COM-port. Set the **Enable PTT Transfer** checkbox to enable rerouting the PTT signal.

Port name - COM-port number.

DTR/RTS - select the COM-port line, which is used for transferring the PTT commands. Set one of the DTR/RTS line checkboxes to set it as the control line.

There are three LEDs on the E-Coder panel, from left to right:

- 1) Lights **green** when the VFO B is active
- 2) Lights **red** when on TX
- 3) Lights **orange** when the RX2 is active

5.3.6 Features menu

In the **Features** menu you can set other programs to be launched along with the ExpertSDR2.

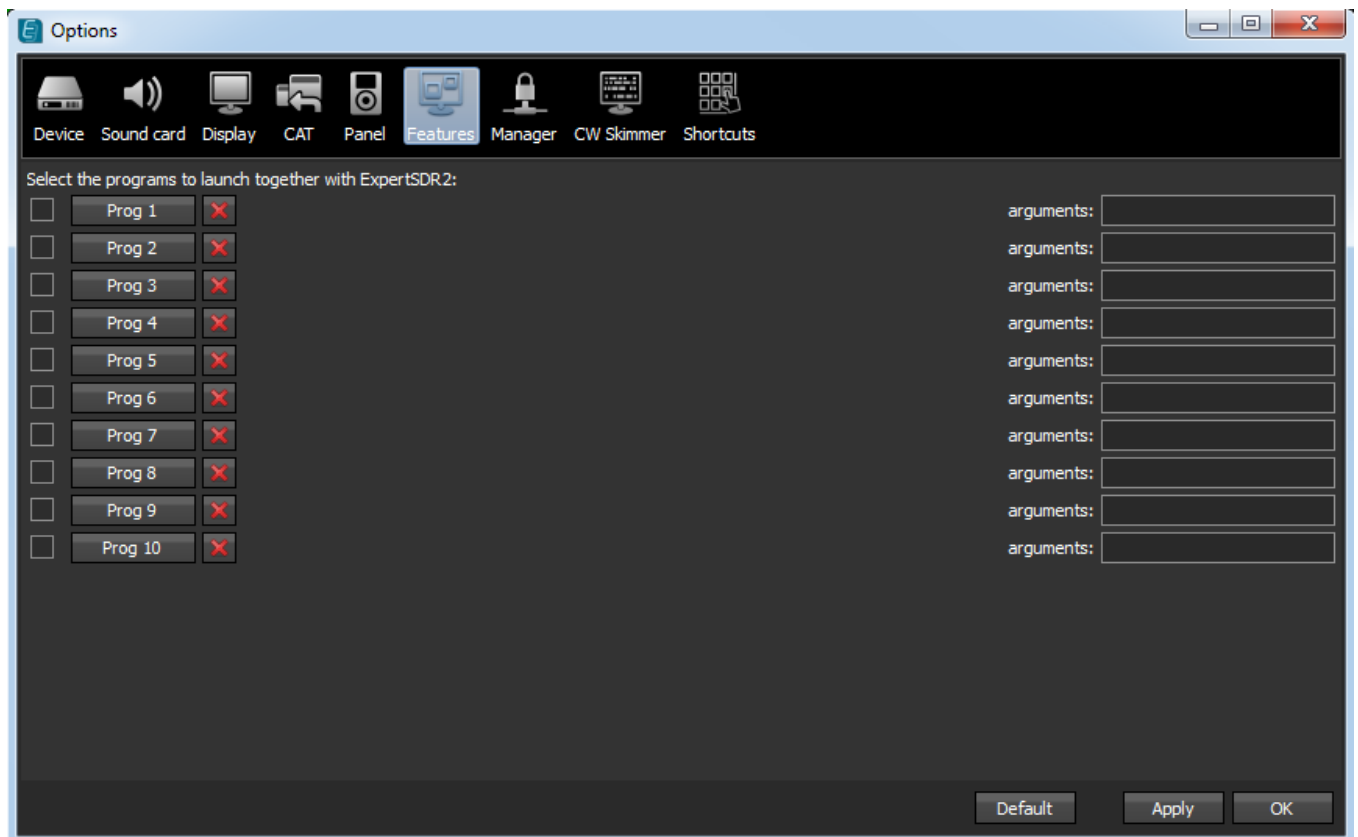

Enable checkbox - Enable autorun.

Set the **Enable** checkbox in front of the corresponding program in the list.

Program 1-10 - program's button.

Press the **Prog X** button to open the File explorer and select .exe file of the required program.

Delete button - Delete program.

Press the **Delete** button if you want to remove a program from the autorun list.

Arguments - Argument input box.

Enter some text in the **arguments** input box for the corresponding program.

Note:

- ◆ Arguments allow to the same program to be launched with different settings files etc.
 - ◆ Read an instruction for your software, to know which arguments are supported.
-

5.3.7 ExpertSync menu

In the **Manager** menu you can see the network synchronization settings between the SunSDR2 PRO and other Expert Electronics devices.

This interface allows you to synchronize the tuning frequency, mode type and RX/TX between several Expert Electronics devices via the ExpertSync software ([you may download it from here](#)).

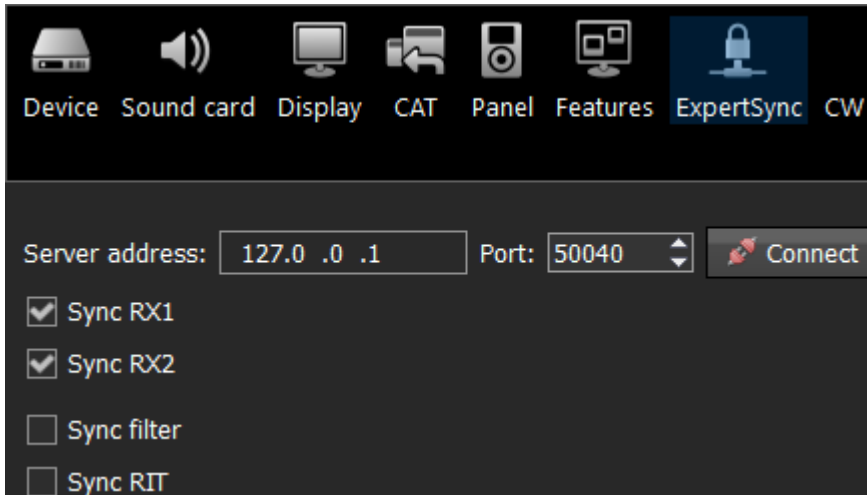

- **Server address** - ExpertSync server IP address.
Enter the ExpertSync server IP address. If the the ExpertSync server is launched on the transceiver's PC, then the address will be 127.0.0.1.
- **Port** - Data exchange port.
Enter the exchange port number in the **Port** input box.
- **Connect** - Start the connection.
Press the **Connect** button to launch the connection between the transceiver's software and ExpertSync. Blue indicator means there is a connection.
- **Sync RX1** - RX1 receiver sync button.
Set the **Sync RX1** checkbox to synchronize the RX1 receiver with the remote RX1 receiver.
- **Sync RX2** - RX2 receiver sync button.
Set the **Sync RX2** checkbox to synchronize the RX2 receiver with the remote RX2 receiver.
- **Sync filter** - set the **Sync filter** checkbox to synchronize the filter bandwidth with the other device connected via the ExpertSync software.
- **Sync RIT** - set the **Sync RIT** checkbox to synchronize the receive frequency offset (RIT) with the other device connected via the ExpertSync software.

5.3.8 CW Skimmer menu

In the **CW Skimmer** menu, you can see the connection settings between the transceiver software and CW Ckimmer software or Internet server-spotter.

Settings in the **CW Skimmer** menu has two identical tabs RX1 and RX2 with connection settings for each software receiver, let's take a look at one of them.

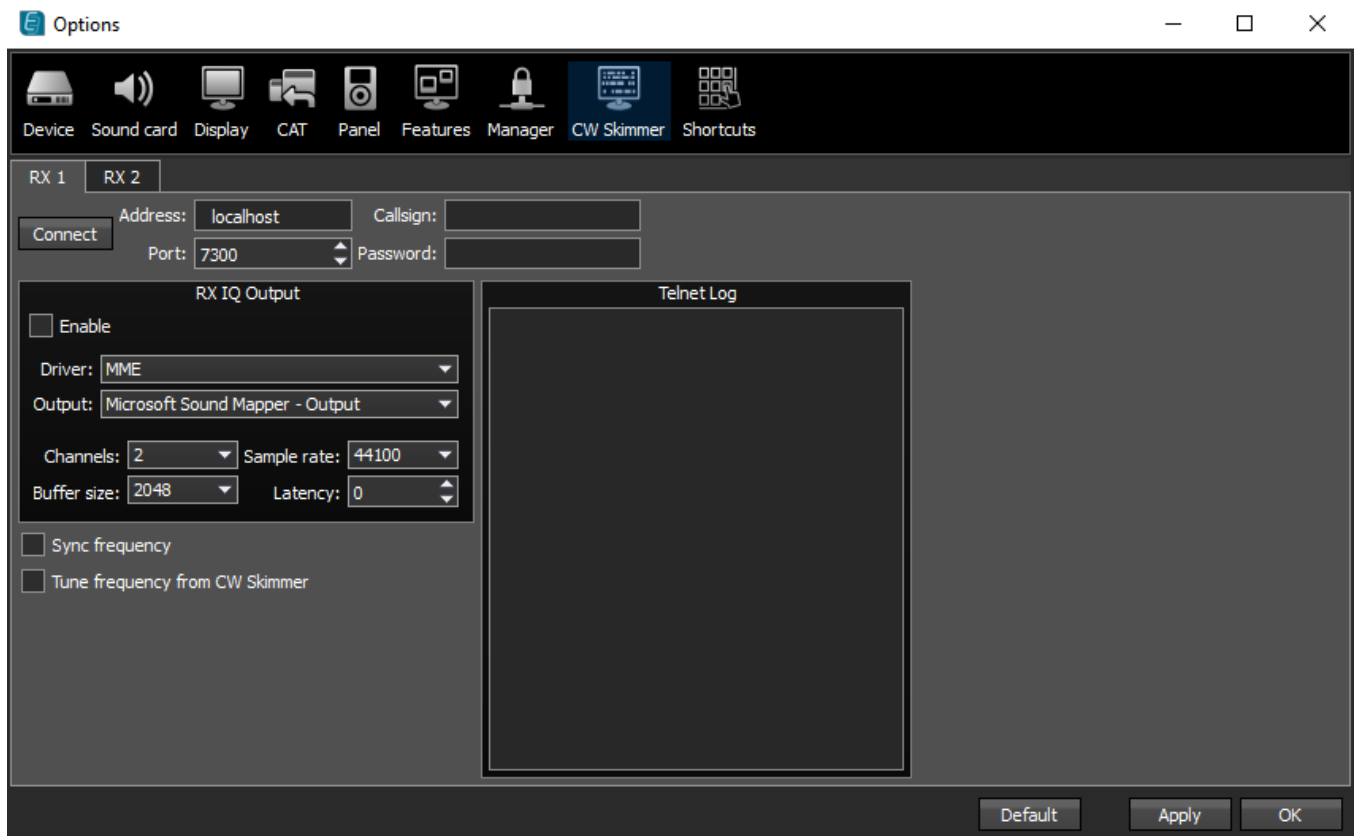

- **Connect** - Button to launch the connection with the CW Skimmer software or Internet server-spotter.

Press the **Connect** button, after adjusting all settings, to make a connection with the CW Skimmer software or Internet server-spotter.

- **Address** - IP address or DNS name of the CW Skimmer/server.
Enter this 127.0.0.1 address or localhost, if you want to connect to the CW Skimmer, which is installed on the transceiver's PC.
- **Port** - Data exchange port.
Enter the exchange port number in the **Port** input box.
- **Callsign** - Callsign input box.
Enter your callsign if the server requires it.
- **Password** - Password.
Enter the password if the server requires it.

To transfer the IQ signal in the CW Skimmer you need to adjust the settings of the audio device in the **RX IQ output** category, it consists of:

- **Enable** checkbox - Enable the IQ signal transfer from the ExpertSDR2 to the CW Skimmer.
- **Driver** - Audio device driver type.
- **Output** - Audio device physical output.

- **Channels** - Amount of the used channels of the audio device.
- **Sample rate** - Sampling frequency.
- **Buffer size** - Buffer size.
- **Latency** - Signal delay time.

Note:

❖ *If CW Skimmer is installed on the transceiver's PC, then for the signal output you need to use Virtual Audio Cable.*

- **Sync frequency** - set the **Sync frequency** to synchronize the CW Skimmer frequency with ExpertSDR2 frequency.
- **Tune frequency from CW Skimmer** - CW Skimmer set the ExpertSDR2 frequency. Set the **Tune frequency from CW Skimmer** to tune the ExpertSDR2 frequency by the mouse click on the station in the CW Skimmer.

5.3.9 Shortcuts menu

In the **Shortcuts** menu, you can see the shortcut key combinations settings.

With the key combinations, you can control the transceiver from your keyboard.

Note:

❖ *Shortcuts will be active only if the transceiver's software window is in focus.*

<input checked="" type="checkbox"/> Enable			
Command	Shortcut	Shortcut RX1	Shortcut RX2
Start Software	Press shortcut		
Options	Press shortcut		
RX2	Press shortcut		
Bandscope	Press shortcut		
Memory Panel	Press shortcut		
Increase Sample Rate	Press shortcut		
Decrease Sample Rate	Press shortcut		
Set RX Antenna	Press shortcut		
Set TX Antenna	Press shortcut		
Mute	Press shortcut	Press shortcut	Press shortcut
RF Gain Up		Press shortcut	Press shortcut
RF Gain Down		Press shortcut	Press shortcut

- **Enable** - Enable shortcuts.
Set the **Enable** checkbox to activate assigned shortcuts.
- **Command** - Functions column.
In the **Command** column displayed all transceiver's functions available for shortcuts.
- **Shortcut** - Main shortcuts column.
In the **Shortcut** column you can set the main transceiver's functions.
- **Shortcut RX1** - RX1 receiver shortcuts column.
In the **RX1 shortcut** column you can set RX1 receiver functions.
- **Shortcut RX2** - RX2 receiver shortcuts column.
In the **RX2 shortcut** column you can set RX2 receiver functions.
- **Press shortcut** - Shortcut button.
Press the **Shortcut** button, then press the key combination on the keyboard.
- To delete a shortcut, press the Del button on the keyboard.

5.3.10 IQ Recorder menu

In the **IQ Recorder** menu, you can select a folder where you will store IQ recordings.

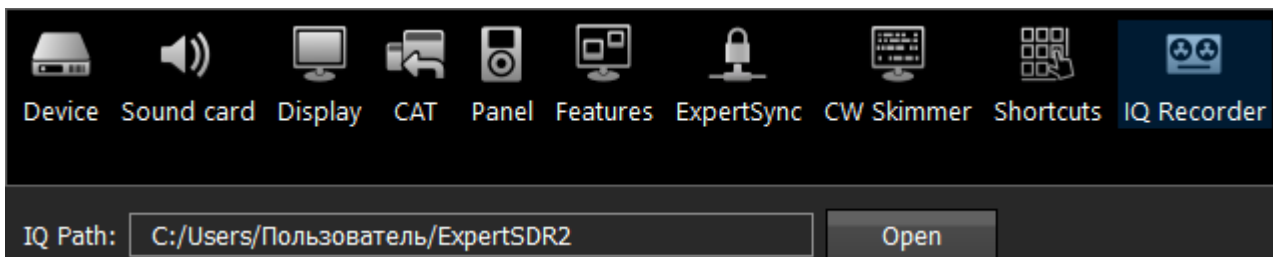

This is the first step on a way to a complete IQ Player.

5.3.11 TCI menu

In the **TCI** menu, you can select a port for TCI connection of ExpertSDR2 with a third-party software, with TCI support, and set the **Enable** checkbox.

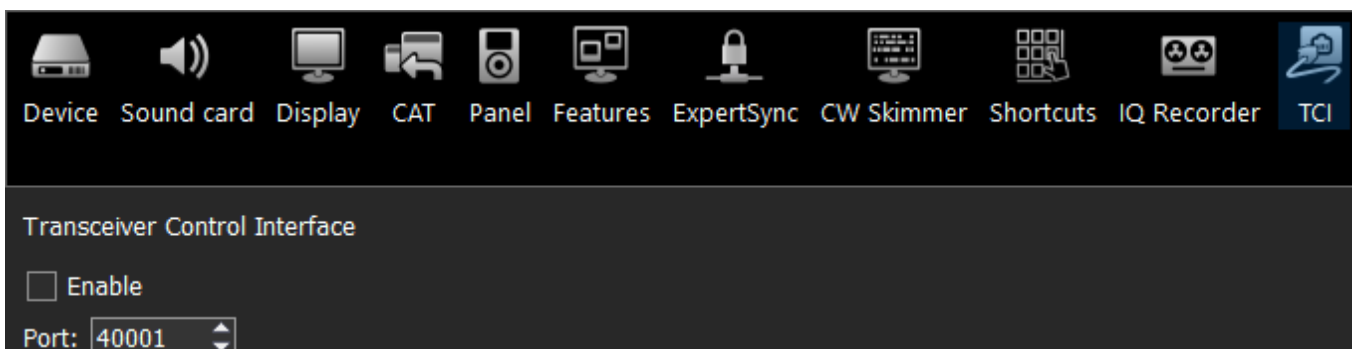

TCI - Transceiver Control Interface was developed by Expert Electronics company, for simple and still advanced connection between the ExpertSDR2 and third-party software. TCI has all required control commands similar to CAT system, but even more, it can transfer IQ-streams from the ExpertSDR2 to clients (third-party software such as signal Skimmers, etc) via local network and the Internet, CW macroses and Audio In/Out streams for digital modes (will be

added soon). TCI is the universal multi-client interface (you can connect it to Loggers, Skimmers, PAs, Antenna switches etc. at the same time).

<https://github.com/maksimus1210/TCI> - link to the list of files with the description of the interface in English and Russian and source code of the demo-client software with TCI support.

5.3.12 Spot settings menu

In the **Spot settings** menu, you can adjust spot settings you receive from CW Skimmer and telnet clusters.

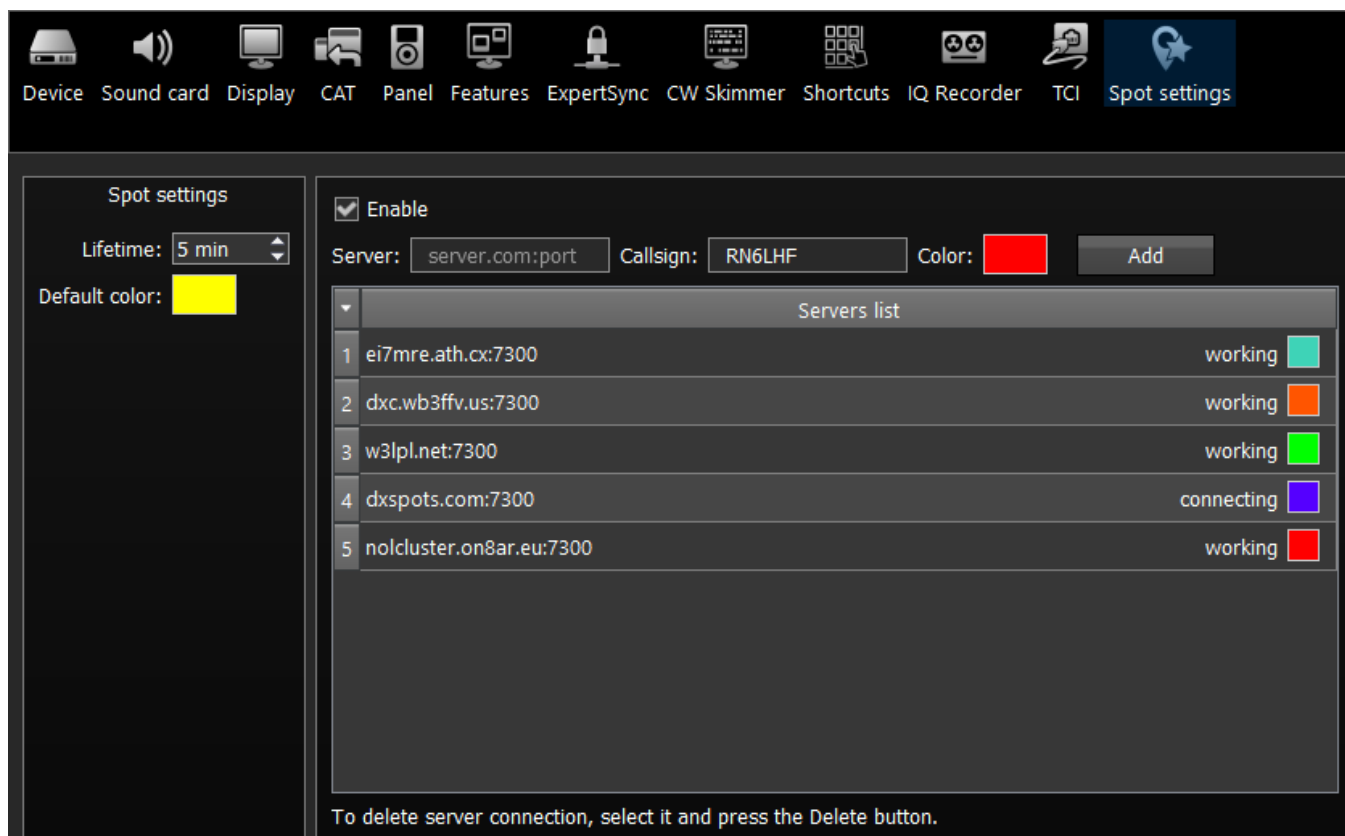

In the **Spot settings** section (left part of the menu) you can set up **Lifetime** and **Default color** for spots received from CW Skimmer.

In the right half of the menu you can add connections to telnet clusters to receive spots. To add a cluster, enter a server address (you may find examples on this website <http://www.dxcluster.info/telnet/index.php>), enter your callsign and select a certain color, press the **Add** button, it's done.

To delete a server connection, select it and press the Delete button on your keyboard.

Note:

• Don't forget to enable the **Show spots** checkbox in the [Spectrum tab](#) ⁶⁴.

6 TECHNICAL CHARACTERISTICS

6.1 Receiver

Characteristic	Value
RX frequency range, MHz	0,09 ... 65; 95 ... 148
ADC type	LTC2209
RF ADC clock frequency, MHz	160
RF ADC resolution, bit	16
Independent software receivers	2 (+2 SubRX)
Sample rate for each receiver, kHz	39; 78; 156; 312 @ 24 bit
Sensitivity, uV	0.07
Maximum width of the Bandscope, MHz	80
Blocking Dynamic Range (BDR), dB	130
Dynamic Range over IMD3 (2 kHz), dB	>100
Reciprocal Mixing Dynamic Range (2 kHz), dB	>110
SNR, dBm	-130 (with 500 Hz bandwidth)
ENOB, bit	14
SFDR, dB	90-100 (depends on the RX frequency)
Local oscillator (TCXO), ppm	20 MHz +/- 0.5 ppm
ATT/Preamp	-20 dB; -10 dB; 0 dB; +10 dB
Additional VHF preamplifier, dB	+22

SunSDR2 PRO has a set of octave band pass filters for the HF band, narrow band pass filter for the 2M band and wide filters for entire Nyquist zones 0...65 MHz, 95...155 MHz.

9 x HF octave band pass filters:

160M: 0-2.5 MHz (Chebyshev I - 7 Order)

80M: 2.5-4 MHz (Chebyshev I - 3 Order)

60M: 4-6 MHz (Chebyshev I - 3 Order)

40M: 6-7.3 MHz (Chebyshev I - 3 Order)

30M: 7.3-12 MHz (Chebyshev I - 3 Order)

20M: 12-14.5 MHz (Chebyshev I - 3 Order)

17-15M: 14.5-21.5 MHz (Chebyshev I - 3 Order)

12-10M: 21.5-30 MHz (Chebyshev I - 3 Order)

6M: 30-65 MHz (Chebyshev I - 3 Order)

HF WideRX filter: LPF (low pass filter) 0-65 MHz (Chebyshev I - 7 Order)

Narrow band pass filter for VHF 2M: 144-148 MHz (SAW Filter) - preferred for normal operation

VHF WideRX: 95-155 MHz (Butterworth - 5 Order)

On VHF there is 1 dB attenuation in comparison to HF, which does not influence sensitivity because there an +22 dB VHF LNA.

6.2 Transmitter

Characteristic	Value
TX frequency range, M	All amateur bands (160-6; 2 M)
RF DAC clock frequency, MHz	640
RF DAC resolution, bit	14
Built-in audio DAC resolution, bit	24
Maximum output power in HF, W	20
Maximum output power in VHF, W	8
TX IMD3, dB	25-30 dB on HF/VHF bands
TX filters	LPF on DAC output: 202 MHz (Eleptic - 7 order) 8 x LPF: 160M: (Eleptic - 5 order) 80M: (Eleptic - 5 order) 60-40M: (Eleptic - 5 order) 30-20M: (Eleptic - 5 order) 17-15M: (Eleptic - 5 order) 12-10M: (Eleptic - 5 order) 6M: (Eleptic - 5 order) 2M: (Eleptic - 5 order)

6.3 Other

Characteristic	Value
Dimensions L x W x H, cm (inches)	19.0 x 17.0 x 5.0 (6.5 x 6.5 x 1.38)
Weight, kg (lbs)	1.5 (3.31 lbs)
DC voltage range in RX, V	10..16
DC voltage range in TX, V	12...16
Current consumption RX/TX, A	1.25/5
Maximum power consumption RX/TX, W	19 / 75
Operating temperature, °C (°F)	0...+75 (+32...+167)

7 TRANSCEIVER OPERATIONS

This chapter describes all basic transceiver functionality.

7.1 Local operation

Local operation is a standard way to use the SunSDR2 PRO transceiver. Make the following connections as described below:

1. Connect headphones and microphone to the transceiver. If you have an electret microphone or PC headset, connect the microphone to jack MIC1. If you have a dynamic microphone, plug it into the jack MIC2. Headphones are plugged into the **PHONES** connector;
2. Connect HF-antenna to the A3 connector;
3. Connect the transceiver and a PC with a CAT5 Ethernet cable;
4. Start the ExpertSDR2 software with the red Start button.
5. In the ExpertSDR2 main window select the microphone you are going to use;
6. Open Options→ **Sound Card** menu and make sure that the **Enable** checkbox in the Sound card half is unchecked.
7. Click OK. If everything is done correctly, you will see the air noise on the panorama and hear the sound in the headphones.

7.2 Remote operation

Over the following [link](#) you may find the manual which thoroughly describes how to operate the SunSDR2 PRO transceiver remotely.

7.3 Frequency Tuning

There are several ways of the **frequency tuning**:

- **Fine tuning.**

More accurate tuning can be performed by rotating the mouse wheel with the accuracy specified in the **STEP** menu.

- **Quick tuning by the mouse click.**

On the spectrum, scope mouse cursor looks like the crosshair. Alongside this cursor displayed the exact frequency and dBm level in the certain point. The RX filter moves to this position by the click of the left mouse button.

Note:

•If the **Sub-receiver** or **SPLIT** mode is enabled, to use the **Quick tuning by the mouse click** with the **VFO A** or **VFO B** press the **mouse wheel** on the panorama. The mouse cursor color will change to match the controlled receiver - color of the mouse cursor also match the receiver's tuning line.

•Use both the **Quick tuning by the mouse click** and **Fine tuning** modes. Click on the station and perform a fine tuning with the wheel if you slightly missed.

- **Dragging the RX filter over the spectrum scope.**

Press and hold the left mouse button on the filter, then drag it left/right to the required position.

- **Moving the spectrum, the RX filter stands still.**

Press and hold the right mouse button anywhere on the spectrum, then move the spectrum, the filter will not change its position relatively to the spectrum. Tuning is carried out with the current **STEP** value.

- **Moving the spectrum, the RX filter moves along.**

Press and hold the right mouse button anywhere on the filter and move it left/right.

Note:

•Basically, this is not a way of tuning. It allows observing the air outside the panorama window, not changing the tuning frequency.

- **Click on the digit of the frequency indicator.**

Left button - increase value; right button - decrease value; wheel - all digits on the right become zero.

- **Rotate mouse wheel on the digit of the frequency indicator.**

Rotate forward - increase value; rotate backward - decrease the value.

- **Synchronous tuning by the click on the bandscope.**

Hover the mouse cursor on the required place on the bandscope and click left mouse button - RX filter will move to the required location on both bandscope and panorama.

7.4 Antenna switch

Antenna switch operation:

The SunSDR2 PRO has the antenna switch, for each frequency band, antenna switch saves its own antenna input and output.

When two software receivers are active (RX1 and RX2), antenna input is the same for both receivers (because device have one ADC), but the transceiver's antenna output may differ if software receivers work on different frequency bands.

How antenna switch works with the **RX ONLY** function:

For example: on the 80M band selected the A2 antenna output, and on the 40M band selected the A3 antenna output, if you switch from the 40M band to the 80M band, you'll be able to assign the **RX ONLY** on the A3 antenna output and lock it only for RX. Now if you switch one of the software receivers on the 40M band, the transceiver's antenna switch will detect that the A3 output is locked for RX and won't change it (leave it in a state before switching to the 40M band).



To assign the **RX ONLY** on an antenna input it's required to have at least one free antenna input, e.g. all software receivers should have another antenna output for TX.

"**Save per band**" function in the Antenna switch can be turned off in the drop-down menu. When it's disabled, transmitter output will switch for both software RXs on all bands.

7.5 Voice Recorder Operation

Voice recorder records the signal in the RX filter and the signal of your own microphone in the TX mode.



Record of the receive voice signal:

1. Press the **Rec** button  to start recording.
2. Press again the **Rec** button  to stop recording.

Note:

•Recording of the received signal is available in all mode types.

Record of the microphone signal:

1. Press the **PTT** button on the microphone or the **MOX** button in the software.
Transceiver will turn to the TX mode.
2. Press the **Rec** button  to start recording and begin to speak in the microphone.
3. Press again the **Rec** button  to stop the recording.

Play the recorded signal without transmitting it on the air:

1. Press the **Play** button  with the the right mouse button to play the recorded voice signal in phones or internal speaker. In the meantime the receiver will be silent.
2. When the playback ends you'll hear the air again.

Play the recorded signal with transmitting it on the air:

1. Press the **Play** button  with the left mouse button to play the recorded voice signal in phones and transmit it on the air.
2. When the playback ends you'll hear the air again.

Note:

• If a recorded signal, which was received from the air, wasn't compressed by the transmitter, it has low RMS power - lower, than compressed signal. Voice recorder has its own AGC, it doesn't allow TX signal level to surpass the maximum threshold, to avoid clipping. This AGC has maximum amplitude threshold for audio signal output: +3 dB, it allows an operator to hear slight clipping with a high gain level of voice recorder signal and adjust correct **Volume for TX** coefficient, keeping a good quality of TX signal. The Peak level set in ExpertSDR2 is 0 dB. The RMS signal level is 3 times weaker by amplitude than peak level. TX signal, recorded by the Voice Recorder, is transmitted on the air without processing e.g. TX processing module does not influence signal transmitted via the Voice Recorder.

• Attention, recordings of the air signals should be used for personal use only. SunSDR2 PRO operator bears full responsibility for using the recorded signal.

• You may record your own CQ (come quick) signal and transmit it on the air by pressing the **Play** button 

7.6 Transverter mode operation

Will be available in the ExpertSDR2 1.3.

7.7 Split operation

VFO A/TX, VFO B/TX - SPLIT operation allows you to receive on the VFO A frequency and transmit on the VFO B frequency. You cannot receive on the VFO B frequency in the SPLIT mode.

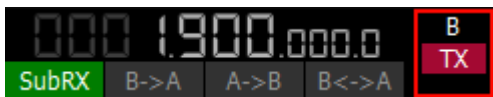

To use the **SPLIT** operation:

1. Activate the **SPLIT** mode by pressing the TX button near the VFO B frequency indicator to turn to TX on this frequency. Flashing red indicator in the software window means the **SPLIT** mode is enabled.
2. Set the required transmit frequency (VFO B) in the **SPLIT** mode. **Disable the SPLIT** mode by pressing the TX button the second time.

Note:

- While you are in **CW** mode with **BREAK IN** function enabled, the transceiver will turn to TX on VFO B frequency automatically when pressing the CW key.
- While in **digital modes** the transceiver will turn to TX on VFO B frequency automatically if received the PTT signal via the CAT-system or a certain COM-port.

7.7.1 SPLIT + Sub RX Operation

In some cases, you need to transmit in a SPLIT mode and simultaneously listen to the transmit frequency (VFO B), in other words, use Sub-receiver.

To enable this mode:

1. Activate the **SPLIT** mode by pressing the TX button near the VFO B frequency indicator. Flashing red indicator in the software window means the **SPLIT** mode is enabled.
2. Activate the Sub-receiver by pressing the **SubRX** button in the software window. Flashing green indicator in the software window means the Sub-receiver is enabled.
3. Set the required TX frequency (VFO B).
4. Listen to the VFO A and VFO B frequencies simultaneously

Note:

- Sub-receiver's red tuning line means that you'll transmit on the VFO B frequency.
- You can switch the TX status between VFO A and VFO B by pressing the RX indicator near any VFO tuned frequency.



7.8 RIT/XIT

Sometimes you need to use RIT/XIT modes.

7.8.1 RIT

The **RIT** offset in the RX mode means that transmission will be held on the tuned frequency and receiving frequency will differ by the offset value.

The offset is displayed as a translucent band on the spectrum scope.

Tuned TX frequency displayed as the red line. RX frequency displayed as the green line with the filter band (on the picture you can see USB mode).

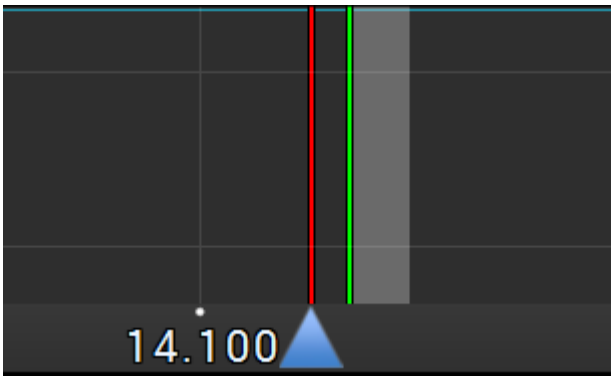

The following values will be displayed below the main receiver's frequency indicator:

RIT: - the frequency offset.

L: and **H:** - low and high filter's edges frequencies.

O: - mouse cursor frequency inside the filter.

To change the filter bandwidth: move the mouse cursor over the filter edge, it will be highlighted, then drag the edge with the left mouse button.

When the **RIT** is enabled, frequency tuning changes a bit:

Press and hold the left mouse button inside the RX filter to move it over the panorama.

Press and hold the left right button inside the RX filter to move the whole panorama with the filter.

Press and hold the middle mouse button inside the RX filter then move the mouse cursor out of the filter bandwidth, the **O:** indicator will show the frequency difference between the mouse cursor and the RX filter.

Note:

*• If the **RIT** offset wasn't reset, when you disable the **RIT** its state will be saved. When you activate the **RIT** next time, the offset will equal the previous value.*

7.8.2 XIT

The **XIT** offset in the TX mode means that receiving will be held on the tuned frequency and transmission frequency will differ by the offset value.

Offset is displayed as a translucent band on the spectrum scope.

RX frequency displayed as the tuned receiver's frequency - green line.

TX frequency displayed as the tuned transceiver's frequency - red line with the filter band (on the picture below you can see USB mode).

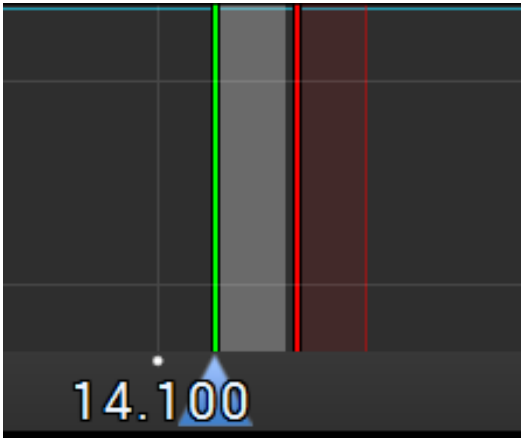

XIT functionality is identical to RIT functionality.

7.9 Digital modes operation

The SunSDR2 PRO transceiver allows you to operate in digital modes with the help of the certain programs (which are not provided by the manufacturer).

Note:

◆ *More information about the SunSDR2 PRO operation in digital modes will be explained in the new version of the User Manual.*

8 RESET SETTINGS AND FIRMWARE

Sometimes you may need to reset IP address and ports of the transceiver, to do that follow the steps below:

1. Switch off the transceiver with the **PWR** button;
2. Press and hold the **RST** button on the rear panel of the transceiver, you will hear a light click;
3. Switch on the transceiver with the **PWR** button. The **LED** will blink different colors (**green** and **red**);
4. Release the **RST** button;
5. Wait until the **LED** turns to constant **green** light, it means the reset went successfully.

After the reset procedure the transceiver will have the default IP-address 192.168.16.200 and ports 50001, 50002.

In case there is something wrong with the device, but you cannot connect with it to figure it out, you may try to do a “deep” reset:

1. Switch off the transceiver with the **PWR** button;
2. Press and hold **L/W** and **RST** buttons simultaneously;
3. Switch on the transceiver with the **PWR** button. The **LED** will blink different colors (**green** and **red**);
4. Release **RST** and **L/W** buttons;
5. LED will blink with green light, launch the ExpertSDR2, press the **red** Start button, transceiver will update the firmware.
6. Wait until the **LED** turns to constant **green** light, it means the reset went successfully.

When the transceiver is switched on, the **RST** button won't be active. Pressing it doesn't have any effect.

Warning!

Do not switch off the transceiver with the PWR button while LED is blinking.

Sometimes you might need to activate the boot-loader mode, to reinstall the transceiver's firmware:

1. Switch off the transceiver with the **PWR** button;
2. Press and hold the **L/W** button on the rear panel of the transceiver (you will hear a light click), switch on the transceiver with the **PWR** button. The **LED** will blink with a single **green** light;
3. Release the **L/W** button;
4. Open ESDR2 software and open Options-> Device menu, Expert tab and press **Firmware update**.
5. After firmware update is finished, **LED** will turn to constant **green** light.

9 REGULATORY REQUIREMENTS

We Expert Electronics LLC declare that SunSDR2 PRO transceiver has been tested in accordance to essential protection requirements of the R&TTE Directive 1999/5/EC on the approximation of the laws of the Member States relating to Radio Spectrum Matters and found the test results indeed meet the limitation of the relevant test standard(s) listed below:

EMC

EN 301 489-1: V 1.9.2 (2011)

EN 301 489-15: V 1.2.1 (2002)

Radio Spectrum

EN 301 783-1: V 1.2.1 (2010)

EN 301 783-2: V 1.2.1 (2010)

Type of Equipment: Base Station

Equipment Class: B

The system is to be operated in accordance with the laws of the telecommunications regulatory agency in the country of use. A license is required to use this equipment, and the operator must comply with the national frequency allocations for the country of use.

Testing Company: Worldwide Testing Service (Taiwan) Co., Ltd.

Place of issue: 6F, NO.58, LANE 188, RUEY-KUANG RD., NEIHU, TAIPEI 114, TAIWAN, R.O.C.

Date of testing: August 14, 2015

Person Responsible: Rex Kao (Signature on file)

RoHS Directive

Expert Electronics LLC confirms that we place on the market products sourced from suppliers who have confirmed that their products are RoHS compliant. Expert Electronics LLC declares that this equipment complies with the restriction of the use of certain hazardous substances in electrical and electronic equipment.

Waste Disposal

The device may not be disposed of with household waste! This device complies with EU Directive on Electronic and electrical equipment (WEEE regulation) and will therefore not be disposed of with household waste. Dispose of the device to your local collection points for electronic equipment!